



IRANTIGH

شرکت ایران تیغ

TOOLS FOR WOODWORKING

Industrial level

2024-2025

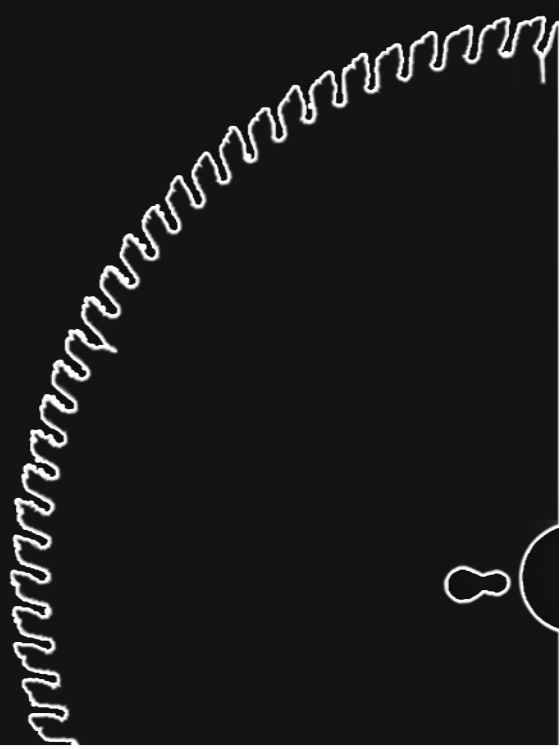

به نام خدا

شرکت ایران تیغ وارد کننده ابزار های تخصصی صنعت چوب و نماینده انحصاری شرکت های ، Tideway ، Hero ، Topuz ، Brk ، Meta در راستای تامین نیازهای تولید کنندگان صنعت چوب آمادگی خود را جهت ارائه انواع تیغ های CNC ، فرزها ، اوور فرزها ، فرز های ماریچ ، منبت ، فرز های تیغچه تعویض ، کلمپ و کولت ، توپی ها ، تیغ اره الماسه و سایر ابزار های تخصصی صنعت چوب و MDF اعلام می نماید. هدف ما برآورده نمودن نیازهای شما با کیفیت مطلوب ، قیمت مناسب و دسترسی آسان می باشد.

مدیریت شرکت ایران تیغ
معین رضایی



TIDEWAY

HERO

TOPUZ



Meta Tools
DO YOUR BEST

BRK MAKINA A.S.
On-Road Partner

تیغ CNC	1-56
تیغ اوورفرزی	57-75
فرز مارپیچ و مثبت	76-79
کلمپ و کولت	80-83
فرز تیغچه تعویض	84-88
توپی	89-90
لوازم	91-95
تیغ اره الماسه	96-104

تیغ دو راهه	71	تیغ تونیک کلاسیک	36	تیغ شماره 1	1
تیغ فاق و زبانه	72	تیغ تونیک کلاسیک سه پله	37	تیغ شماره 1+Z	2
تیغ فاق و زبانه کابینتی	73	تیغ تونیک کاسه ای	38	تیغ شماره 3 کارباید	3
تیغ تونیک بلبرینگ	74	تیغ تونیک کاسه ای	39	تیغ شماره 4 کارباید Z	4
تیغ لبه	75	تیغ تونیک کلاسیک	40	تیغ شماره 5 جای شیشه	5
تیغ برش ماریچ پلکسی و MDF	76	تیغ تونیک کلاسیک	41	تیغ انگشتی	6
تیغ برش ماریچ MDF	77	تیغ تونیک کلاسیک	42	تیغ انگشتی 3D	7
تیغ برش ماریچ چوب	78	تیغ تونیک کلاسیک	43	تیغ 90V درجه	8
تیغ مثبت	79	تیغ تونیک کلاسیک	44	تیغ 90V درجه مخصوص فارسی	9
کلمپ	80	تیغ تونیک کلاسیک	45	تیغ 120V درجه	10
کولت با فشنگی ER32	81	تیغ گل نقطه ای	46	تیغ 140V درجه	11
کولت با فشنگی ER25	82	تیغ تونیک کلاسیک	47	تیغ 150V درجه	12
کولت با فشنگی ER20	83	تیغ تونیک کلاسیک	48	تیغ 130V درجه	13
فرز کف تراش تیغه تعویض	84	تیغ تونیک کلاسیک	49	تیغ 60V درجه	14
فرز کف تراش تیغه تعویض	85	تیغ تونیک کلاسیک	50	تیغ حکاکی	15
تیغ V شکل 90 درجه تیغه تعویض	86	تیغ تونیک کلاسیک	51	تیغ 45V درجه	16
فرز پرداخت تیغه تعویض	87	تیغ تونیک کلاسیک	52	تیغ پروفیل	17
تیغ برش تیغه تعویض	88	تیغ تونیک کلاسیک	53	تیغ کف تراش	18
تویی پرداخت ماریچ	89	تیغ تونیک 15 درجه	54	تیغ ناودانی	19
تویی پرداخت	90	تیغ تونیک نوک تیز	55	تیغ ناودانی	20
مهره کلمپ	91	تیغ تونیک کلاسیک	56	تیغ ناودانی	21
آچار کلمپ دو طرفه ER32	92	تیغ پرداخت	57	تیغ رگال	22
بلبرینگ	93	تیغ پرداخت بلبرینگ پایین	58	تیغ پروفیل کلاسیک	23
پارکینگ	94	تیغ بخ لبه	59	تیغ پروفیل ابرویی	24
تیغچه های پرداخت	95	تیغ معنی لبه	60	تیغ پروفیل نفوذی	25
تیغ اره الماسه MDF بر	96	تیغ بانکی	61	تیغ پروفیل نفوذی	26
تیغ اره الماسه نتویان بر	97	تیغ پروفیل بلبرینگ	62	تیغ پروفیل دو پله	27
تیغ اره الماسه چوب بر	98	تیغ پروفیل لبه	63	تیغ پروفیل دو پله	28
خط زن الماسه یک تکه	99	تیغ پروفیل لبه	64	تیغ پروفیل دو احتنا	29
تیغ اره برش دستگاه پرتابل	100	تیغ پروفیل لبه	65	تیغ پروفیل بشقاب	30
تیغ اره الماسه چوب بر چند تیغ MULTY RIPPPING SAW	101	تیغ پروفیل لبه بلبرینگ	66	تیغ دستگیره مخفی	31
تیغ اره الماسه چوب بر چند تیغ RIPPPING SAW	102	تیغ پروفیل لبه سه پله	67	تیغ تونیک کلاسیک	32
تیغ اره الماسه آلومینیوم بر	103	تیغ بشقاب بلبرینگ	68	تیغ تونیک کلاسیک	33
تیغ اره الماسه دستگاه فارسی بر	104	تیغ تاج	69	تیغ تونیک کلاسیک	34
		تیغ اتصال سر به سر	70	تیغ تونیک کلاسیک سه پله	35

R	Code No:کد	D عرض (mm)	H کارگیر (mm)	d شفت(mm)	Z دندانه
1	TD-101812	2	8	8	2
2	TD-101801	3	8	8	2
3	TD-101816	3	20	8	2
4	TD-101802	4	10	8	2
5	TD-101815	5	20	8	2
6	TD-101600	6	20	6	2
7	TD-101803	6	20	8	2
8	TD-101804	8	20	8	2
9	TD-101205	8	32	12	2
10	TD-101206	10	20	12	2
11	TD-101207	10	32	12	2
12	TD-101209	12	38	12	2
13	TD-101210	12	50	12	2
14	TD-101215	12	70	12	2
15	TD-101212	14	50	12	2
16	TD-101211	16	50	12	2

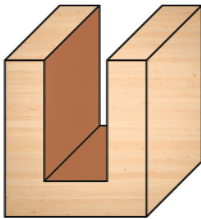

R	Code No: کد	D عرض (mm)	H کارگیر (mm)	d شفت (mm)	Z دندانه
1	TD-101820	8	20	8	Z ₂ +1
2	TD-101221	8	32	12	Z ₂ +1
3	TD-101219	9	20	12	Z ₂ +1
4	TD-101222	10	20	12	Z ₂ +1
5	TD-101223	10	32	12	Z ₂ +1
6	TD-101225	12	20	12	Z ₂ +1
7	TD-101226	12	30	12	Z ₂ +1
8	TD-101228	16	50	12	Z ₂ +1

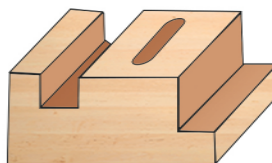
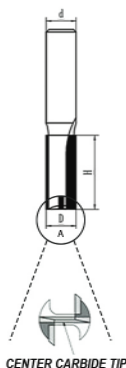

تیغ شیارزن کاربرد

R	Code No: کد	D عرض (mm)	H کارگیر (mm)	d شفت (mm)	Z دندانه
1	TD-101831	4	20	8	2
2	TD-101810	5	16	8	2
3	TD-101832	6	25	8	2
4	TD-101233	8	32	12	2



TIDEWAY

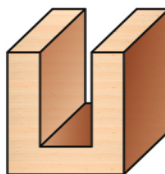

R	Code No: کد	D عرض (mm)	H کارگیر (mm)	d شفت (mm)	Z دندانه
1	TD-101834	4	20	8	3
2	TD-101235	6	20	12	3
3	TD-101237	8	32	12	3

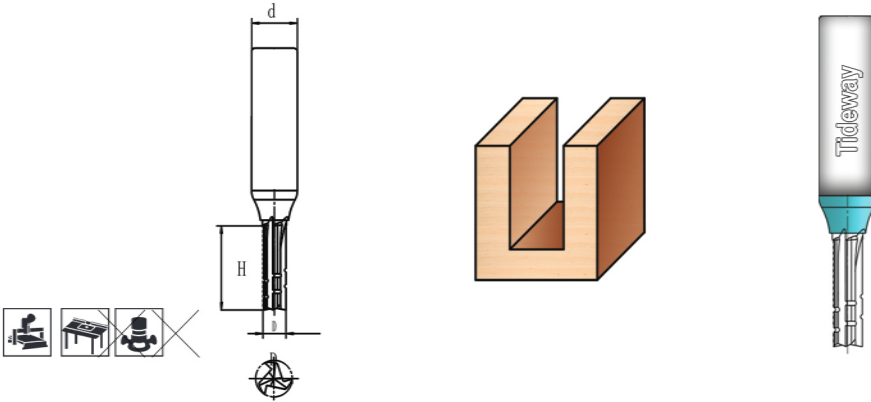

R	Code No: کد	D عرض (mm)	H کارگیر (mm)	d شفت (mm)	Z دندانه
1	TD-101240	8	19	8	2

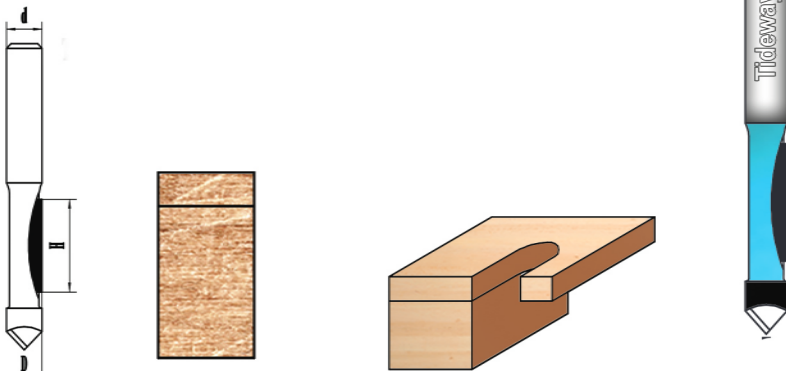

Drawings are 1:1 scale



R	Code No: کد	D عرض (mm)	H کارگیر (mm)	d شفت (mm)	Z دندانه	R شعاع
1	TD-201860	3	8	8	2	1/5
2	TD-201861	4	4	8	2	2
3	TD-201863	6	6	8	2	3
4	TD-201262	8	6	12	2	4
5	TD-201864	10	6/5	8	2	5
6	TD-201265	12	9/5	12	2	6
7	TD-201266	16	11	12	2	8
8	TD-201267	19	12	12	2	9/5
9	TD-201268	25/4	16	12	2	12/7
10	TD-201271	31/75	19	12	2	15/9
11	TD-201269	38/1	22/22	12	2	19/0/5
12	TD-201270	50/8	31/8	12	2	25/4

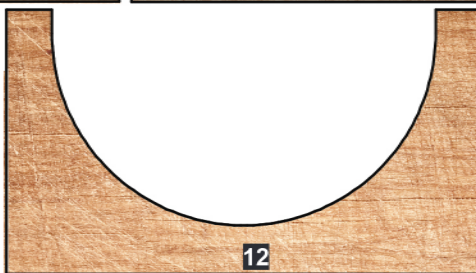
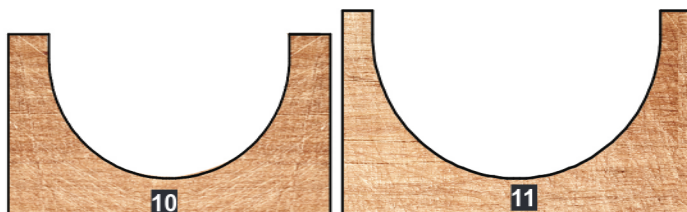
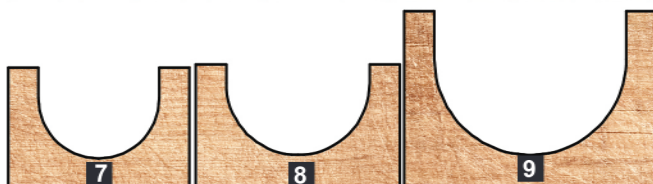

TIDEWAY

R	Code No: کد	D عرض (mm)	H کارگیر (mm)	d شفت (mm)	Z دندانه	R شعاع
1	TD-201275	8	20	8	2	4
2	TD-201279	12	50	12	2	4

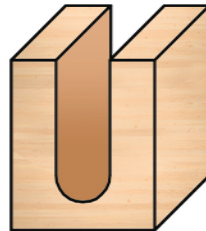
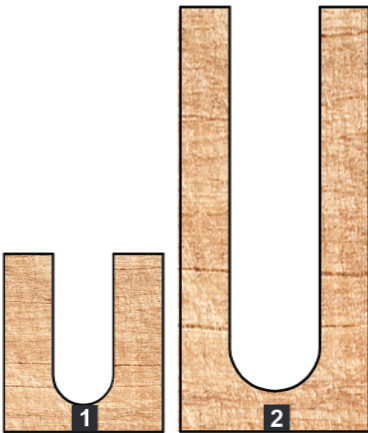

Drawings are 1:1 scale

R	Code No: کد	D عرض (mm)	H کارگیر (mm)	d شفت (mm)	Z دندانه	a زاویه
1	TD-301238	19	16	12	2	90
2	TD-301230	38/1	25	12	2	90
3	TD-301237	68	41	12	2	90

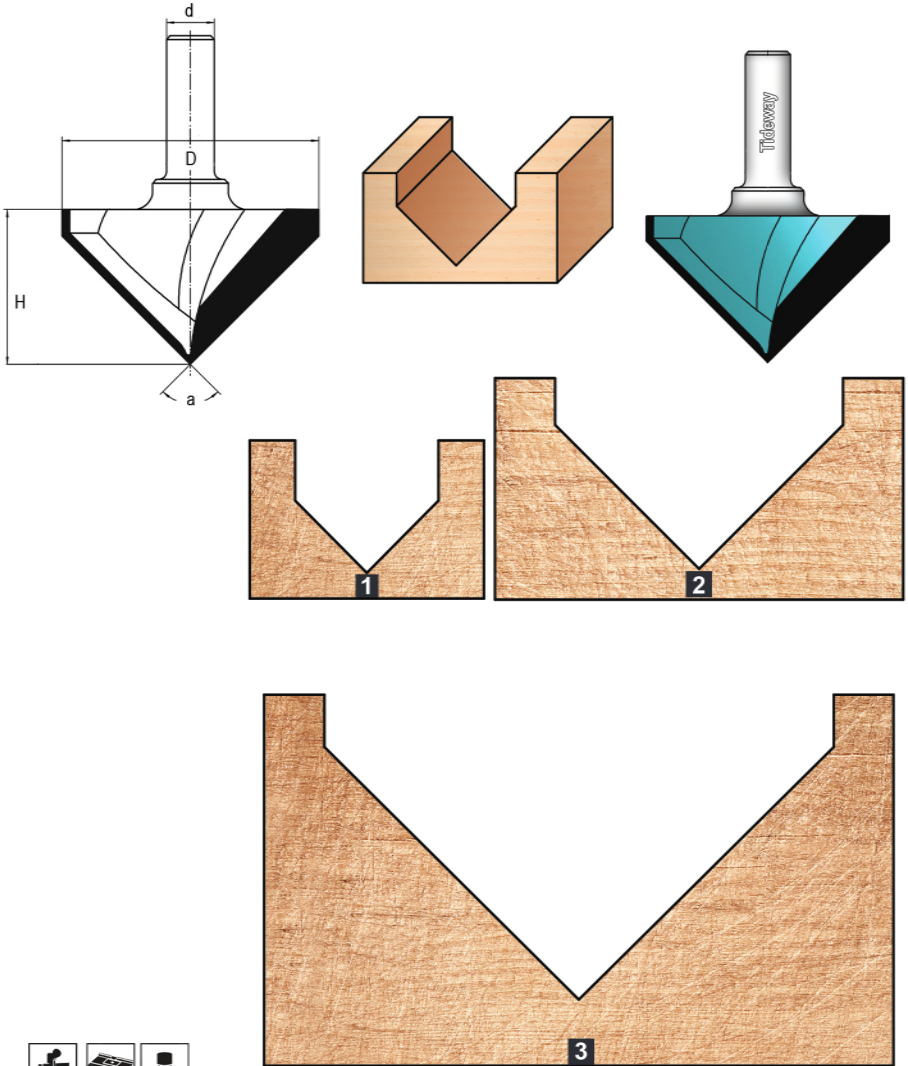

Drawings are 1:1 scale

R	Code No: کد	D عرض (mm)	H کارگیر (mm)	d شفت (mm)	Z دندانه	a زاویه
1	TD-301230-1	38/1	22	12	2	90s

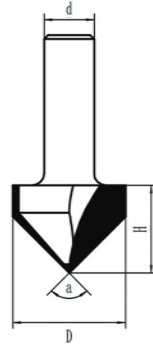
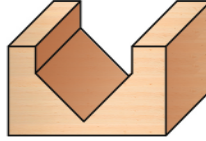
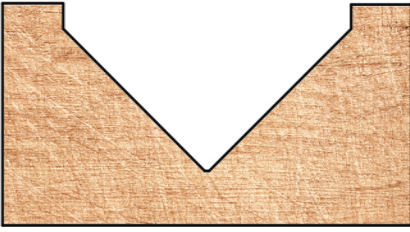

Drawings are 1:1 scale



R	Code No: کد	D عرض (mm)	H کارگیر (mm)	d شفت (mm)	Z دندانه	a زاویه
1	TD-301231	40	16/5	12	2	120
2	TD-301234	60	23/4	12	2	120

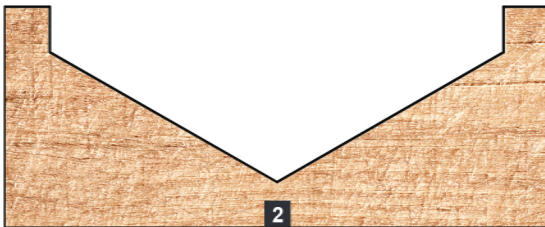
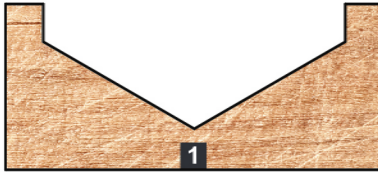
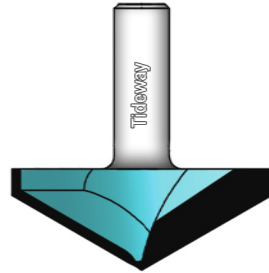
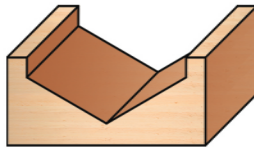
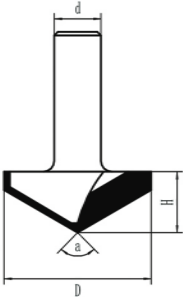

Drawings are 1:1 scale



R	Code No: کد	D عرض (mm)	H کارگیر (mm)	d شفت (mm)	Z دندانه	a زاویه
1	TD-301232	40	12/7	12	2	140
2	TD-301235	69	19	12	2	140

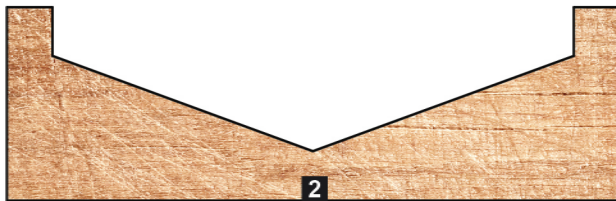
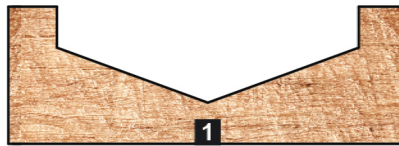
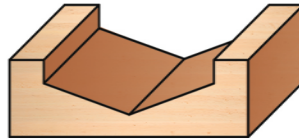
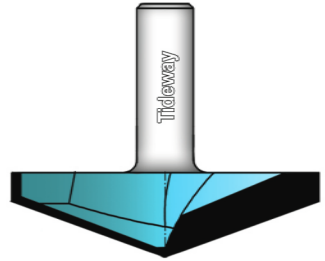
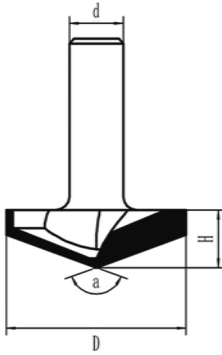

Drawings are 1:1 scale

R	Code No: کد	D عرض (mm)	H کارگیر (mm)	d شفت (mm)	Z دندانه	a زاویه
1	TD-301236	40	12/7	12	2	150
2	TD-301239	60	15	12	2	150
3	TD-301242	80	17	12	2	150

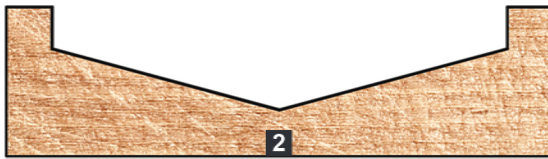
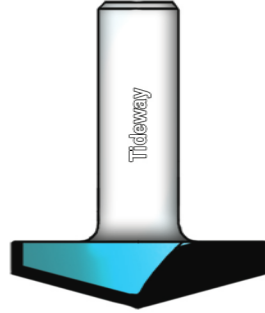
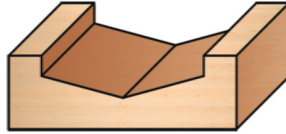
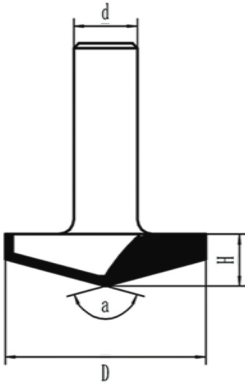

Drawings are 1:1 scale



R	Code No: کد	D عرض (mm)	H کارگیر (mm)	d شفت (mm)	Z دندانه	a زاویه
1	TD-301243	60	19	12	2	130

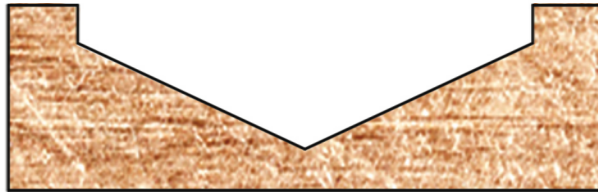
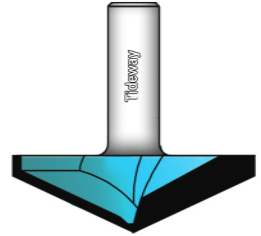
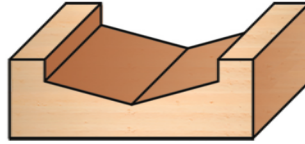
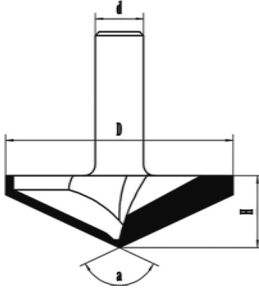

Drawings are 1:1 scale

R	Code No: کد	D عرض (mm)	H کارگیر (mm)	d شفت (mm)	Z دندانه	a زاویه
1	TD-301833	12/7	10/9	8	2	60

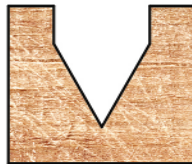

Drawings are 1:1 scale

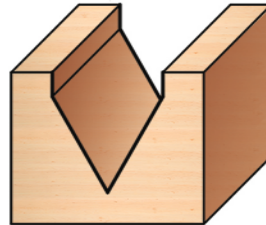

R	Code No: کد	D عرض (mm)	H کارگیر (mm)	d شفت (mm)	Z دندانه	a زاویه
1	TD-301240	15/1	13/1	12	3	60

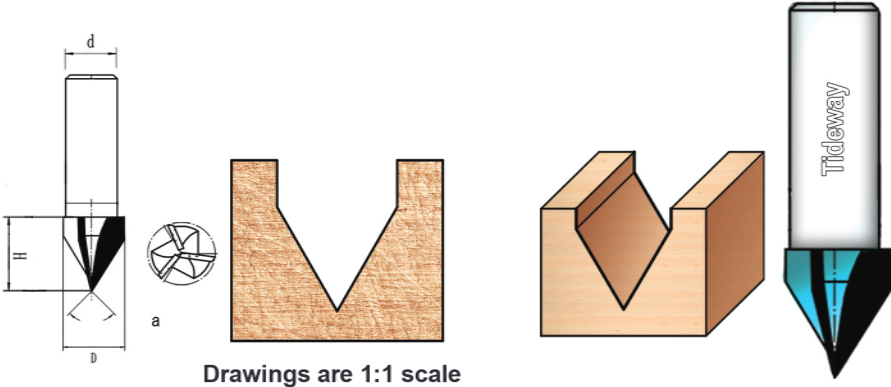

Drawings are 1:1 scale



R	Code No: کد	D عرض (mm)	H کارگیر (mm)	d شفت (mm)	Z دندانه	a زاویه
1	TD-301245	22/2	32	12	2	45

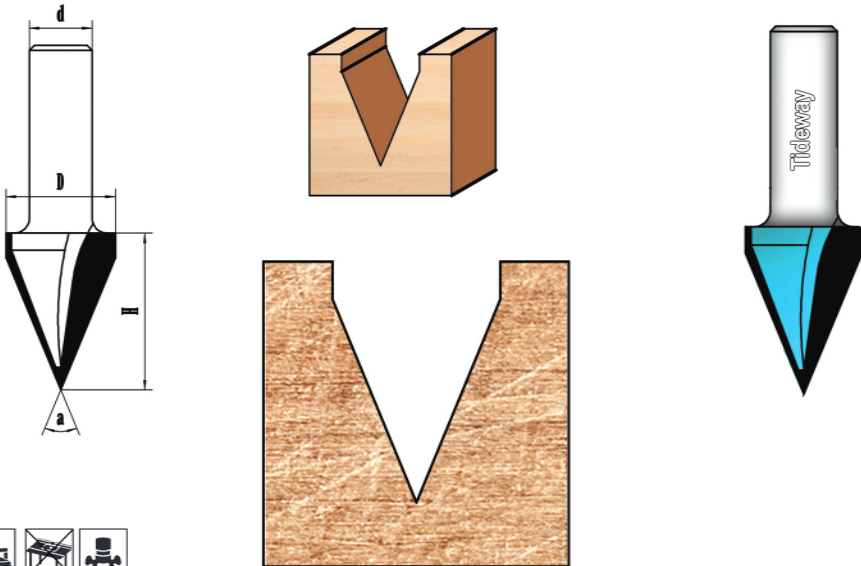

Drawings are 1:1 scale



R	Code No: کد	D عرض (mm)	H کارگیر (mm)	d شفت (mm)	Z دندانه	R شعاع
1	TD-401206	12/7	9/5	12	2	6/5
2	TD-401205	19/1	13	12	2	9/5
3	TD-401207	25/4	16	12	2	12/5
4	TD-401209	31/18	18	12	2	15.9
5	TD-401208	50	26	12	2	25

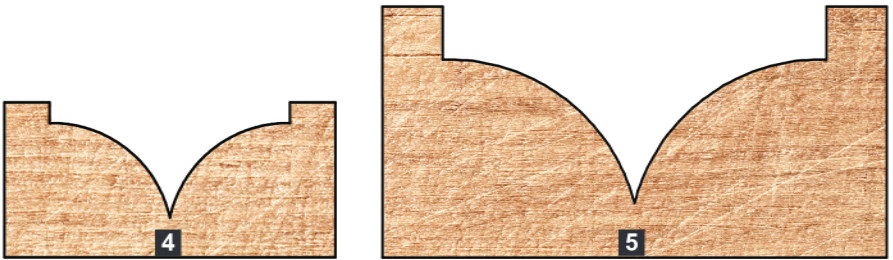
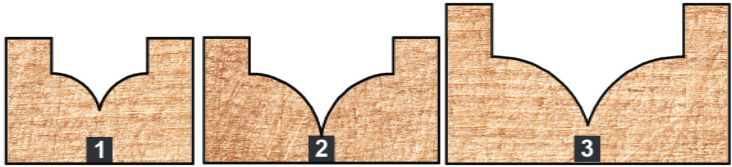
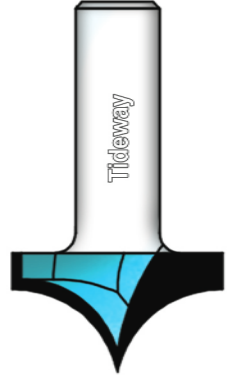
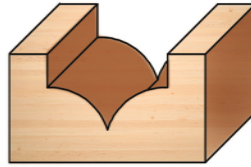
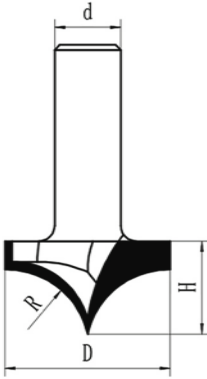

Drawings are 1:1 scale



TIDEWAY

R	Code No: کد	D عرض (mm)	H کارگیر (mm)	d شفت(mm)	Z دندانه
1	TD-201249	15	20	12	2
2	TD-201251	20	20	12	2
3	TD-201250	25/4	20	12	2
4	TD-201252	38/1	20	12	2
5	TD-201254	50	15	12	2

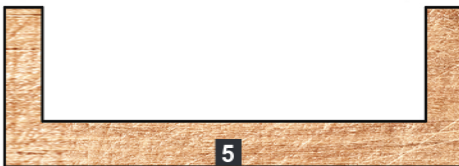
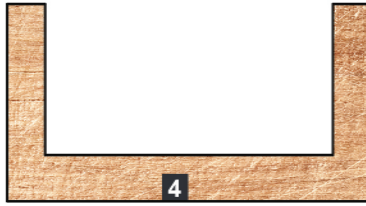
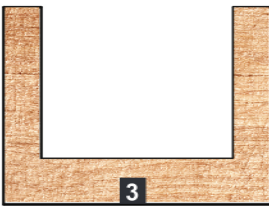
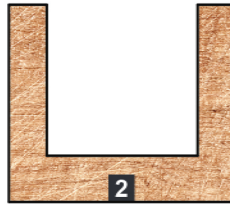
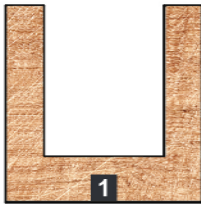
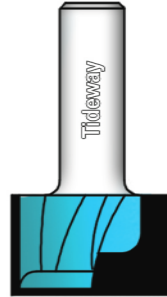
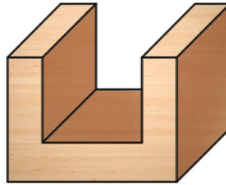
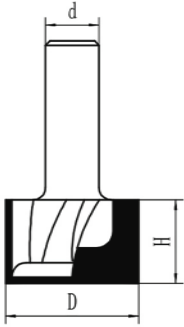

Drawings are 1:1 scale



R	Code No: کد	قطر برش	D عرض (mm)	H کارگیر (mm)	d شفت (mm)	Z دندانه	R شعاع
1	TD-401240	8	33/4	25/4	12	2	12/7
2	TD-401240 old	8	33/4	25/4	12	2	12/7

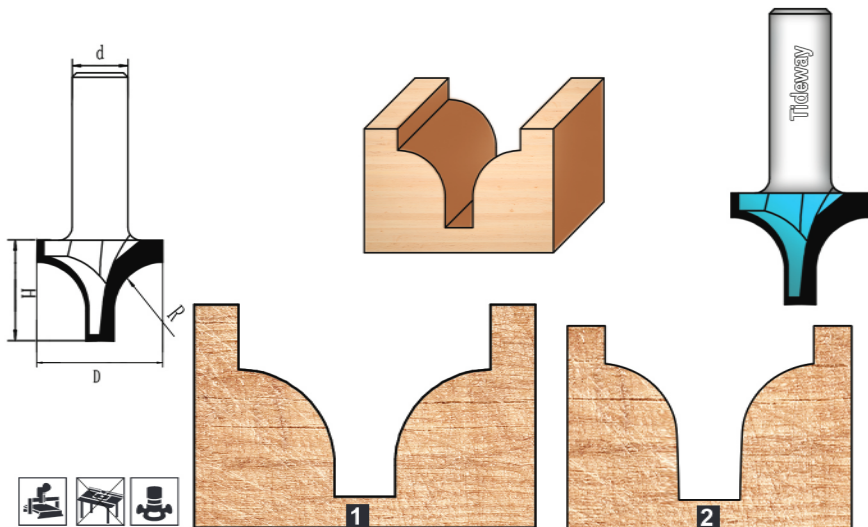

Drawings are 1:1 scale



R	Code No: کد	قطر برش	D عرض (mm)	H کارگیر (mm)	d شفت (mm)	Z دندانه	R شعاع
1	TD-401241	8	25/7	23/5	12	2	6

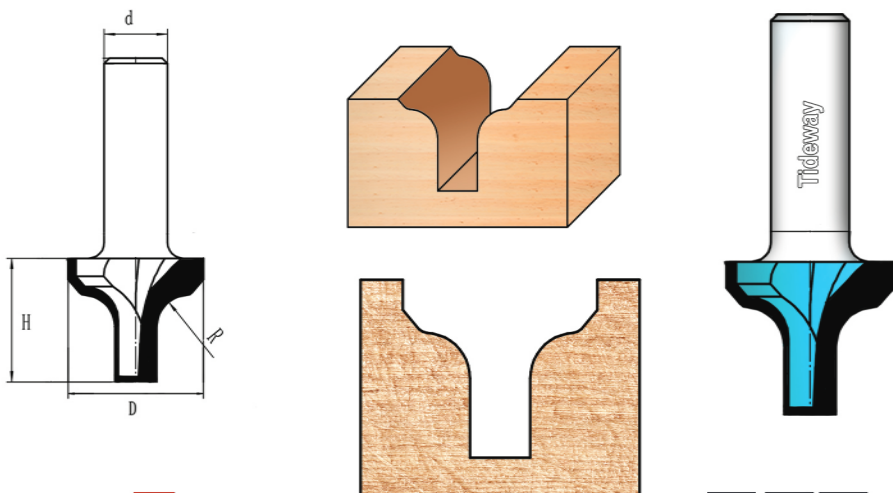

Drawings are 1:1 scale



R	Code No: کد	قطر برش	D عرض (mm)	H کارگیر (mm)	d شفت (mm)	Z دندانه	R شعاع
1	TD-401242	6	31.75	25	12	2	12/7

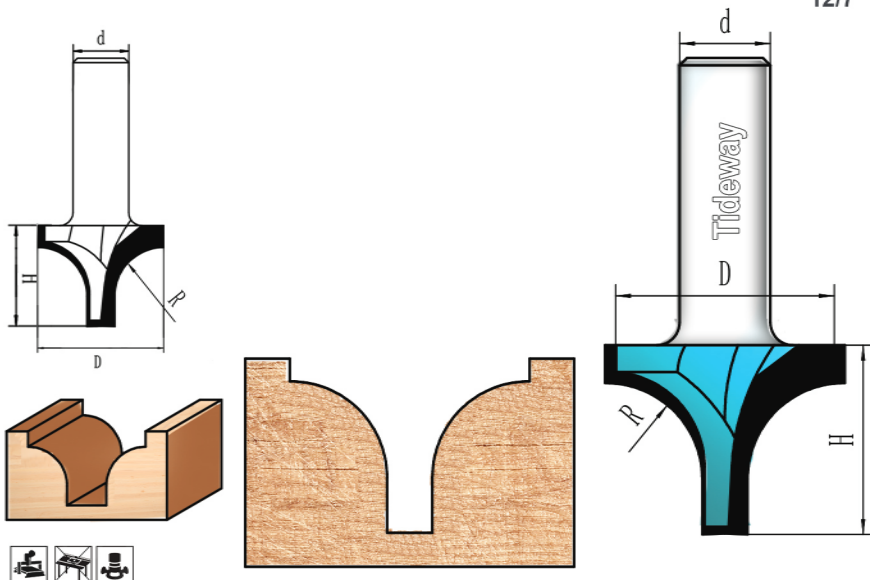

Drawings are 1:1 scale

R	Code No: کد	D عرض (mm)	H کارگیر (mm)	d شفت (mm)	Z دندانه
1	TD-401250	28	16	12	2
2	TD-401250 OLD	28	16	12	2

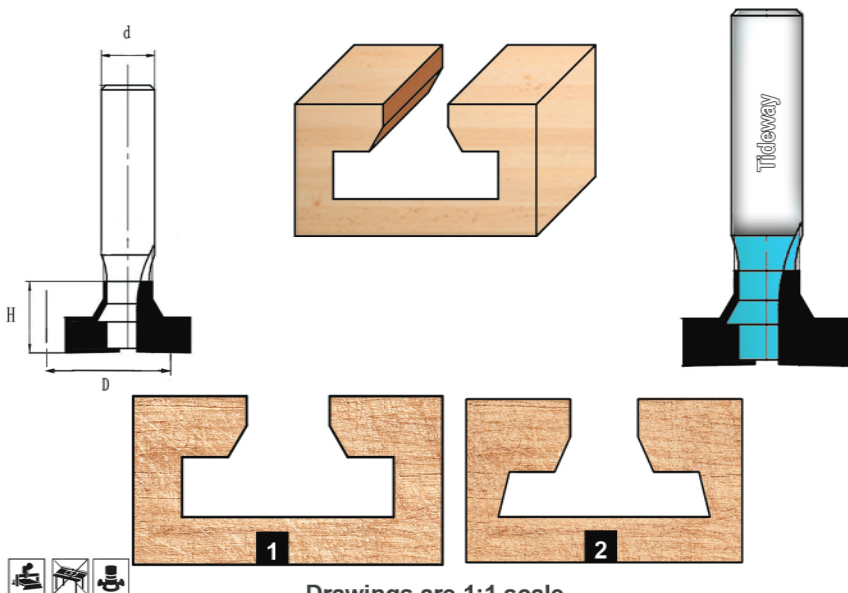

Drawings are 1:1 scale

R	Code No: کد	D عرض (mm)	H کارگیر (mm)	d شفت (mm)	Z دندانه
1	TD-401255	25/4	14/3	12	2
2	TD-401256	44/5	23/8	12	2

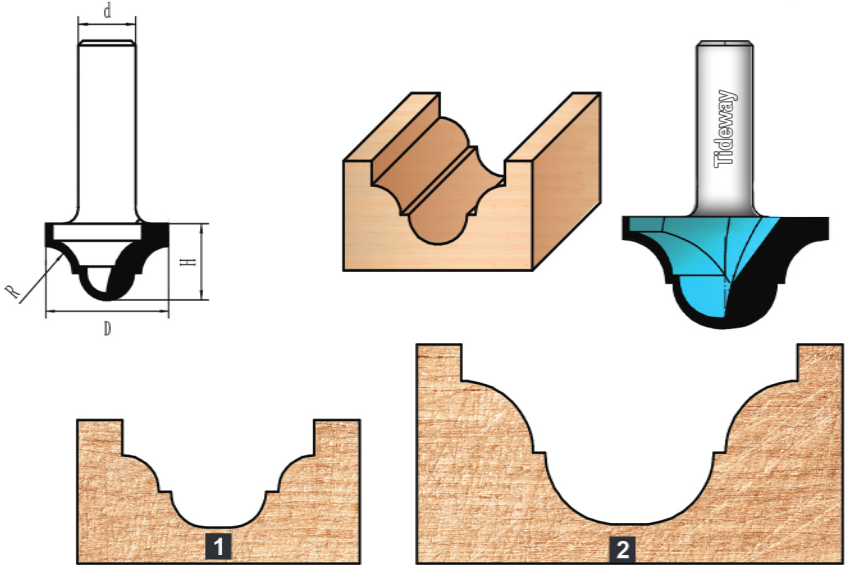

Drawings are 1:1 scale



R	Code No: کد	D عرض (mm)	H کارگیر (mm)	d شفت (mm)	Z دندانه
1	TD-401857	19/2	6/3	8	2
2	TD-401258	34/9	15/9	12	2

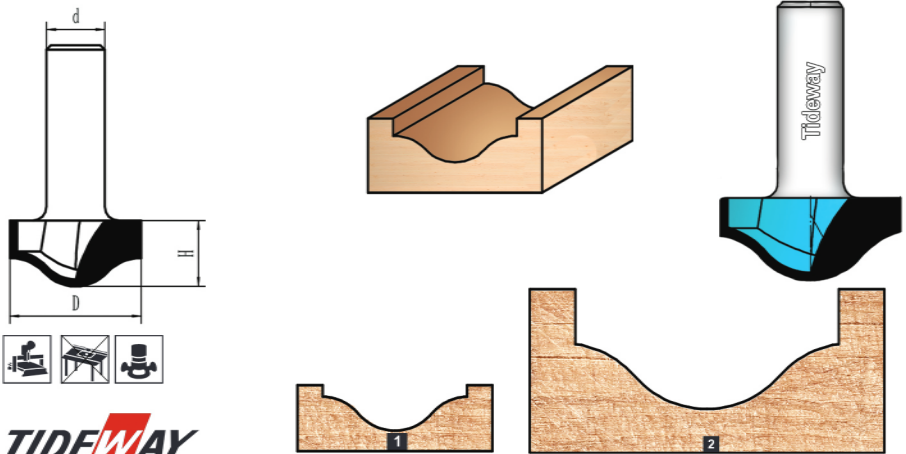

Drawings are 1:1 scale



Code No: کد	D عرض (mm)	H کارگیر (mm)	d شفت (mm)	Z دندانه	R شعاع
TD-401859	24	16	8	2	4/8
TD-401260	31/8	17/5	12	2	4/8

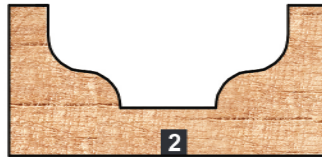
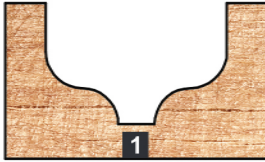
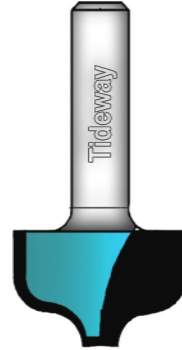
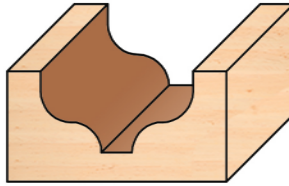
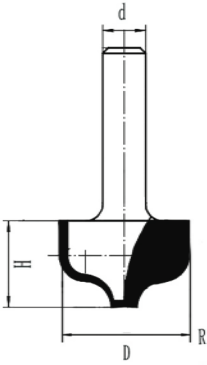

Drawings are 1:1 scale



R	Code No: کد	D عرض (mm)	H کارگیر (mm)	d شفت (mm)	Z دندانه	R شعاع
1	TD-401262	25.4	13.2	12	2	6/71

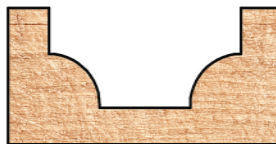
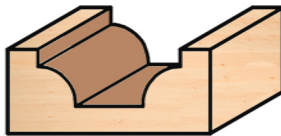
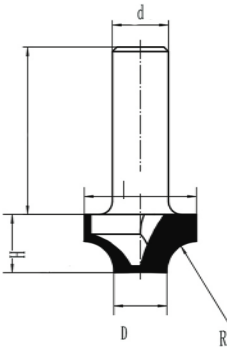

Drawings are 1:1 scale



R	Code No: کد	D عرض (mm)	H کارگیر (mm)	d شفت (mm)	Z دندانه	R شعاع
1	TD-401270	25	15	12	2	5

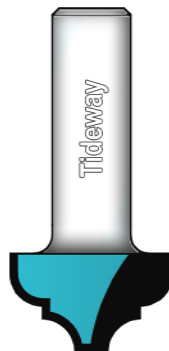
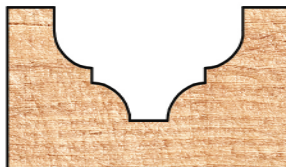
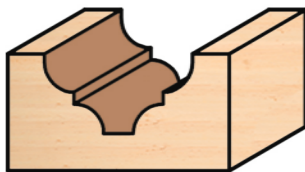
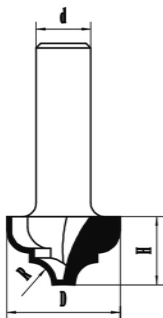

Drawings are 1:1 scale

R	Code No: کد	D عرض (mm)	H کارگیر (mm)	d شفت (mm)	Z دندانه	R شعاع
1	TD-401268	49/5	26/5	12	2	5

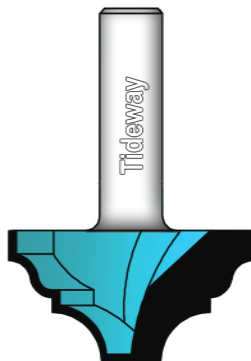
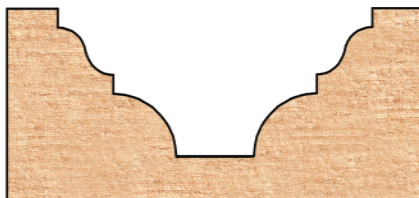
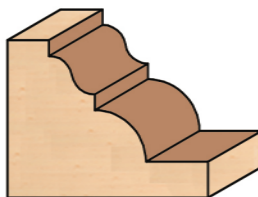
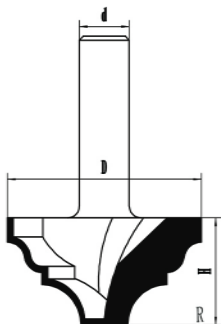

Drawings are 1:1 scale

R	Code No: کد	D عرض (mm)	H کارگیر (mm)	d شفت (mm)	Z دندانه	R شعاع
1	TD-401265	26/9	15/9	12	2	5/55

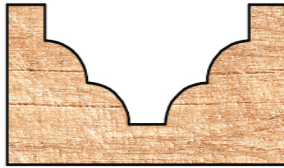
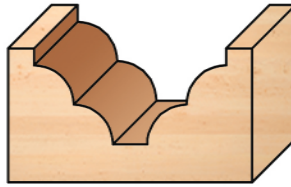
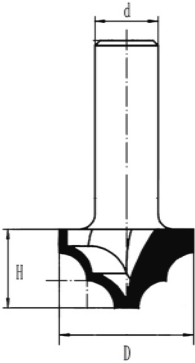

Drawings are 1:1 scale

R	Code No: کد	D عرض (mm)	H کارگیر (mm)	d شفت (mm)	Z دندانه	R شعاع
1	TD-401872	25.4	15/9	8	2	6/35
2	TD-401273	31.75	15/9	12	2	6/35

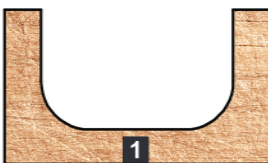
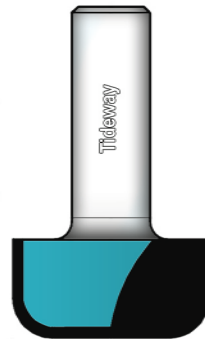
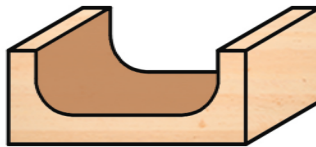
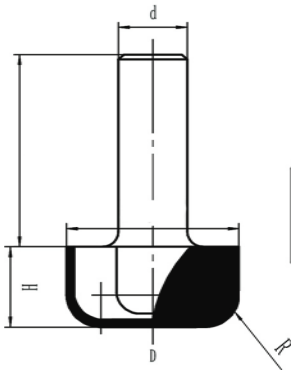

Drawings are 1:1 scale



R	Code No: کد	D عرض (mm)	H کارگیر (mm)	d شفت (mm)	Z دندانه
1	TD-401276	38/1	12	12	2
2	TD-401275	38/1	20/63	12	2

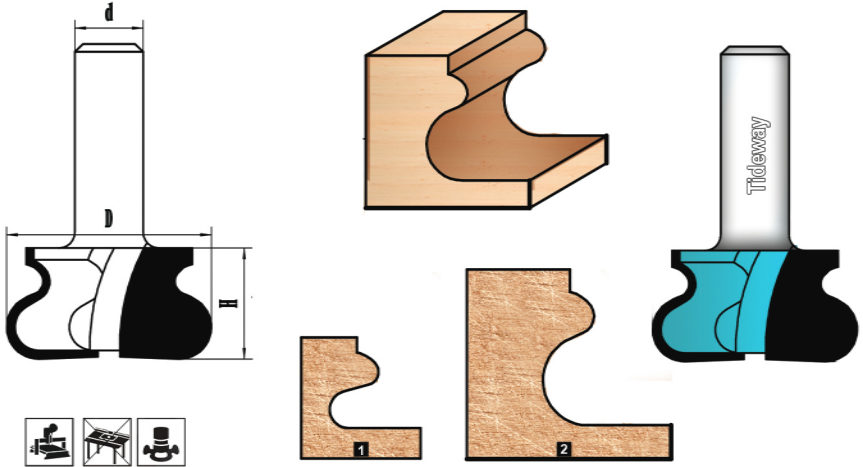

Drawings are 1:1 scale

R	Code No: کد	D عرض (mm)	H کارگیر (mm)	d شفت (mm)	Z دندانه
1	TD-141214	50/8	10/3	12	2

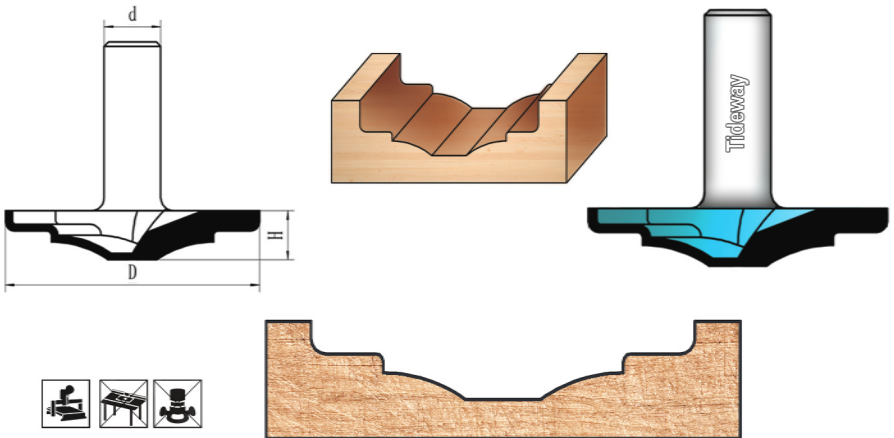

Drawings are 1:1 scale

TIDEWAY

R	Code No: کد	D عرض (mm)	H کارگیر (mm)	d شفت (mm)	Z دندانه
1	TD-141215	50/8	11/1	12	2

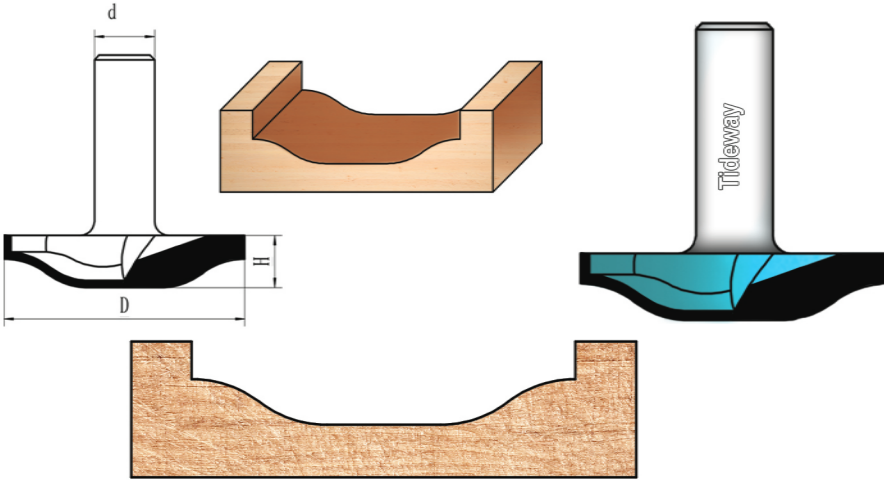

Drawings are 1:1 scale



R	Code No: کد	D عرض (mm)	H کارگیر (mm)	d شفت (mm)	Z دندانه
1	TD-141216	34/9	5/5	12	2

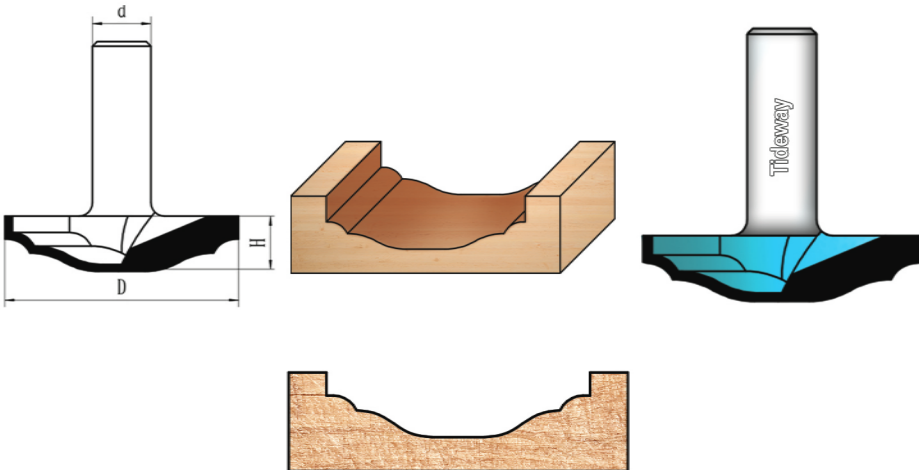

Drawings are 1:1 scale



R	Code No: کد	D عرض (mm)	H کارگیر (mm)	d شفت (mm)	Z دندانه
1	TD-141218	50/8	8/7	12	2

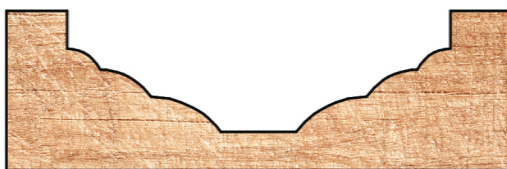
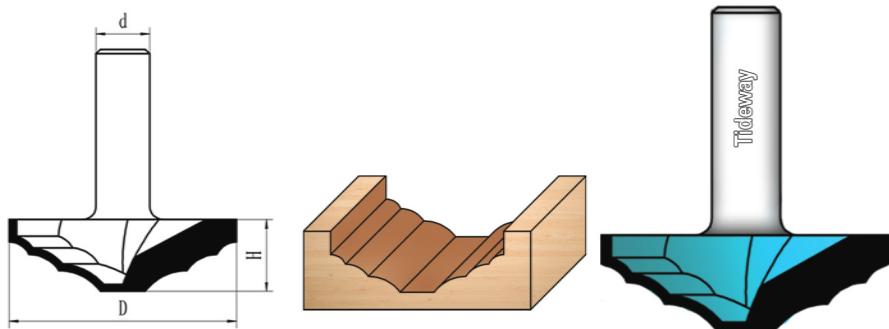

Drawings are 1:1 scale

R	Code No: کد	D عرض (mm)	H کارگیر (mm)	d شفت (mm)	Z دندانه
1	TD-141219	34/9	9/53	12	2
2	TD-141231	44/5	7	12	2

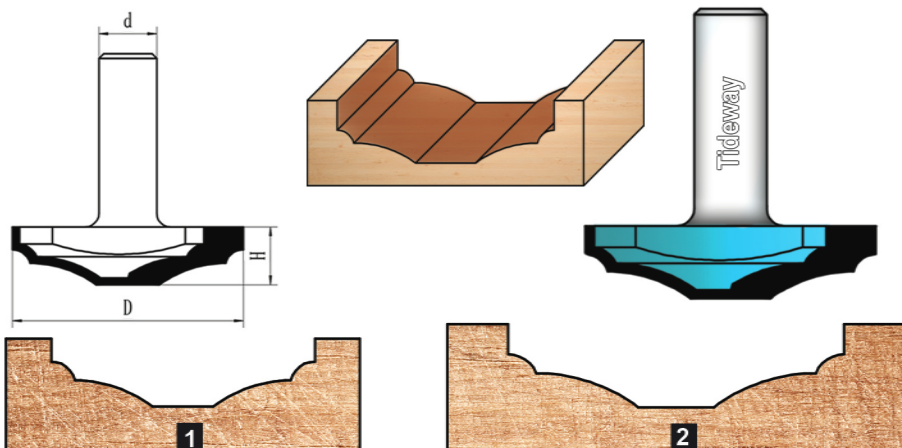

Drawings are 1:1 scale

R	Code No: کد	D عرض (mm)	H کارگیر (mm)	d شفت (mm)	Z دندان
1	TD-141220	50/8	8	12	2

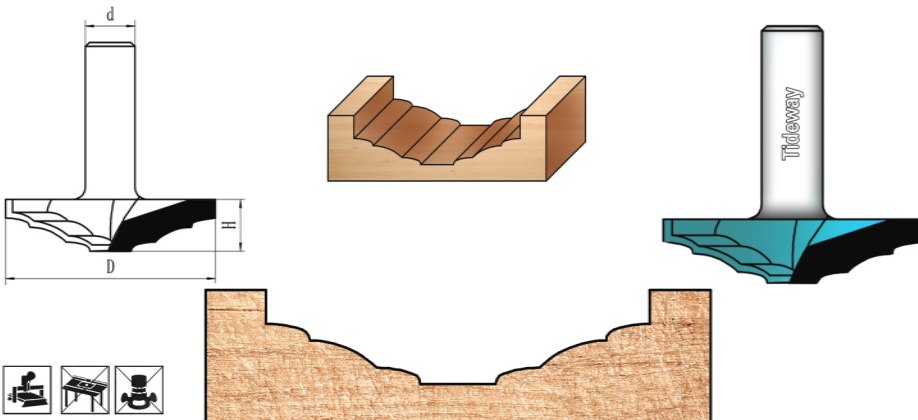

Drawings are 1:1 scale

R	Code No: کد	D عرض (mm)	H کارگیر (mm)	d شفت (mm)	Z دندان
1	TD-141221	63/5	11	12	2
2	TD-141235	95	10	12	2

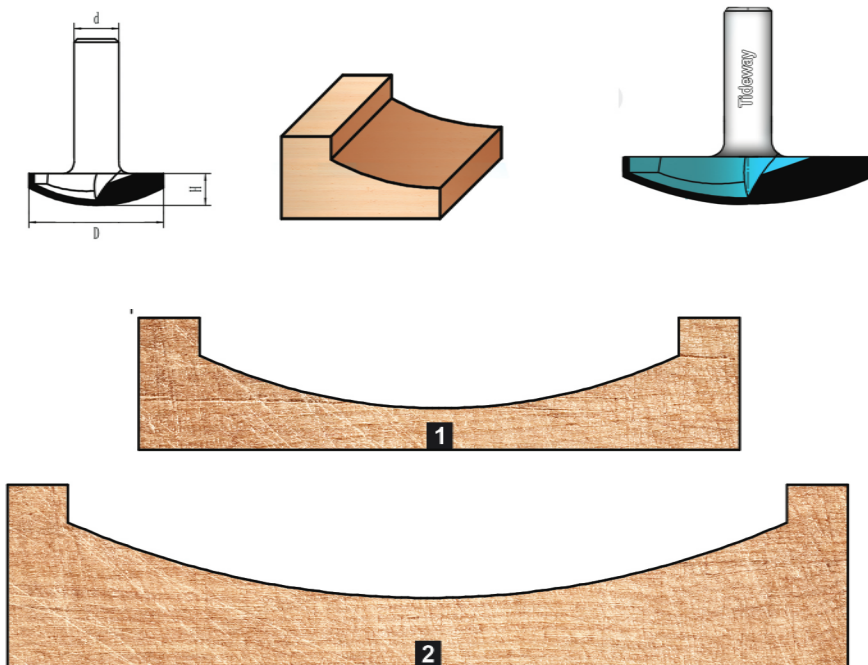

Drawings are 1:1 scale

R	Code No: کد	D عرض (mm)	H کارگیر (mm)	d شفت (mm)	Z دندانه
1	TD-141213	63/5	16	12	2
2	TD-141212	95	18	12	2

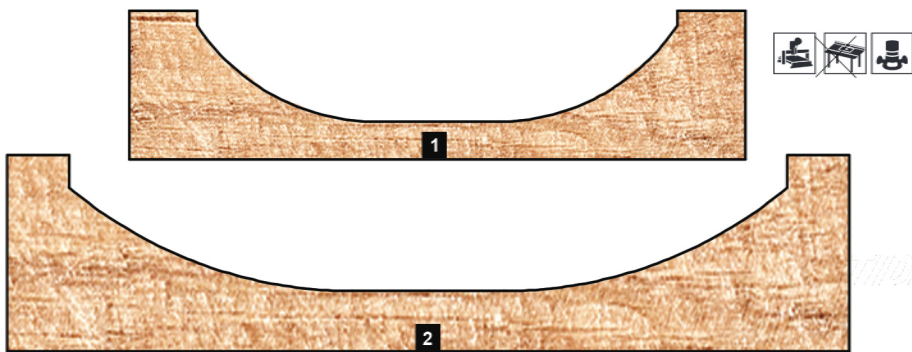
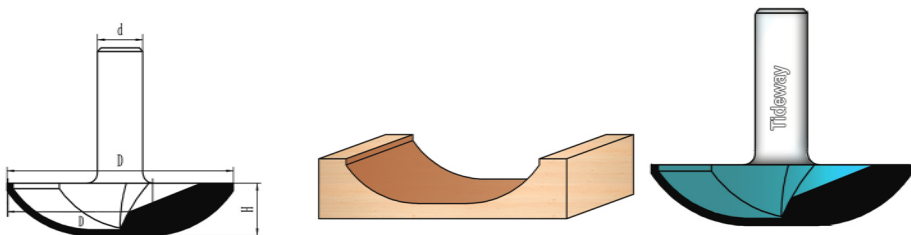

R	Code No: کد	D عرض (mm)	H کارگیر (mm)	d شفت (mm)	Z دندانه
1	TD-141222	44/5	6	12	2

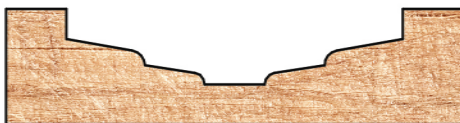
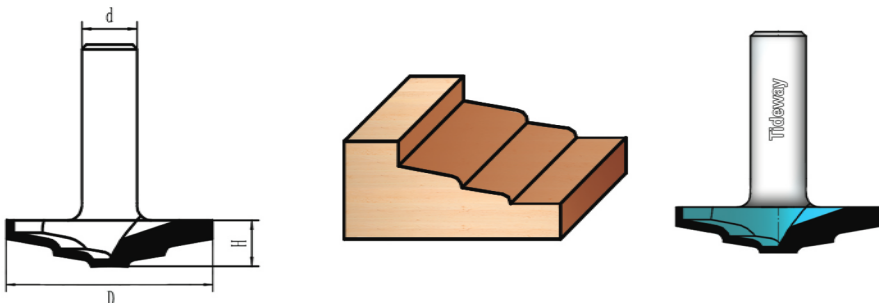

Drawings are 1:1 scale



R	Code No: کد	D عرض (mm)	H کارگیر (mm)	d شفت (mm)	Z دندانه
1	TD-141224	63/5	9/5	12	2

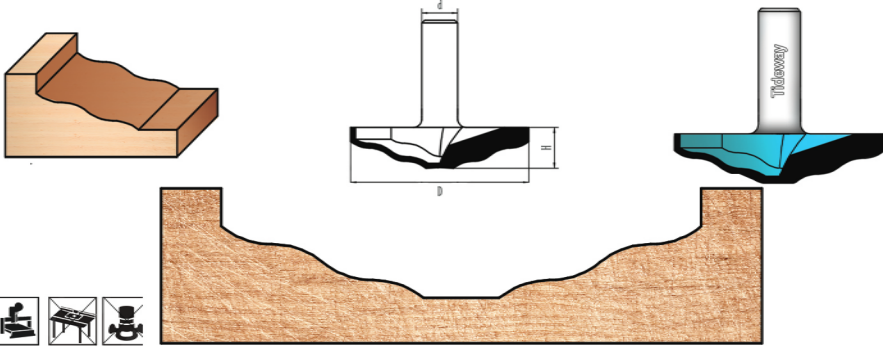

Drawings are 1:1 scale



R	Code No: کد	D عرض (mm)	H کارگیر (mm)	d شفت (mm)	Z دندانه
1	TD-141225	44/5	8	12	2

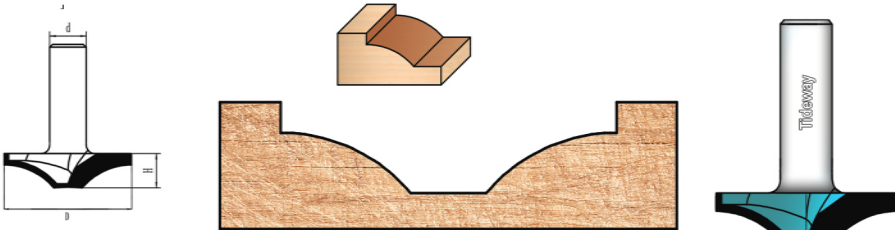

Drawings are 1:1 scale



R	Code No: کد	D عرض (mm)	H کارگیر (mm)	d شفت (mm)	Z دندانه
1	TD-141226	34	7/6	12	2

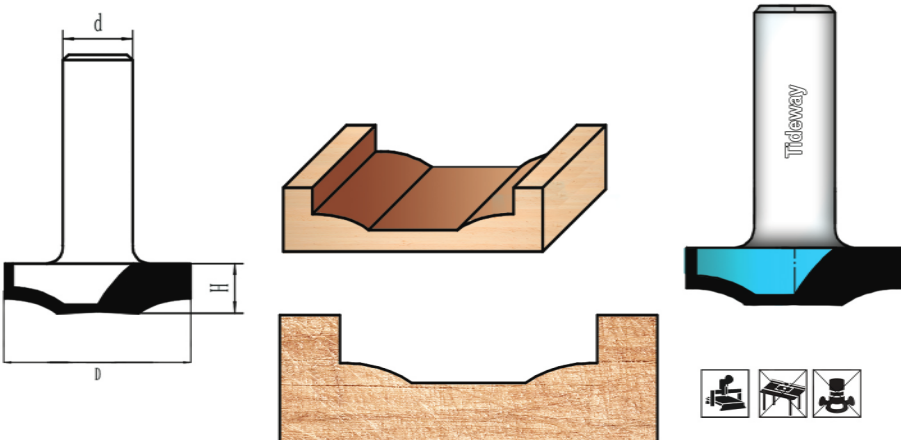

Drawings are 1:1 scale



R	Code No: کد	D عرض (mm)	H کارگیر (mm)	d شفت (mm)	Z دندانه
1	TD-141227	35	8	12	2

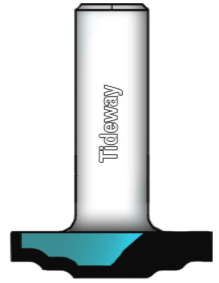
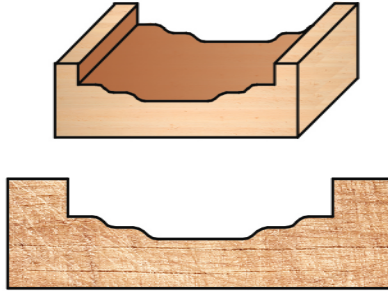
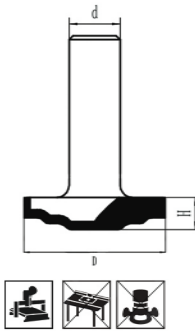

Drawings are 1:1 scale

R	Code No: کد	D عرض (mm)	H کارگیر (mm)	d شفت (mm)	Z دندانه
1	TD-141229	35	9	12	2

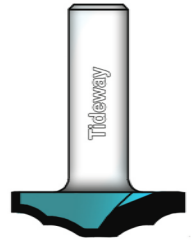
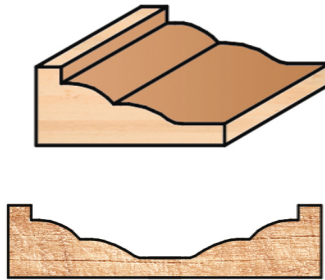
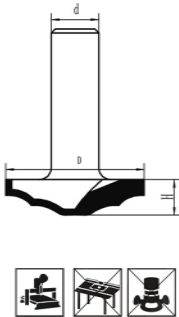

Drawings are 1:1 scale

R	Code No: کد	D عرض (mm)	H کارگیر (mm)	d شفت (mm)	Z دندانه
1	TD-141230	60	17/17	12	2

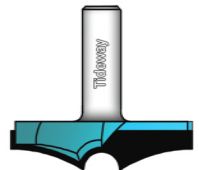
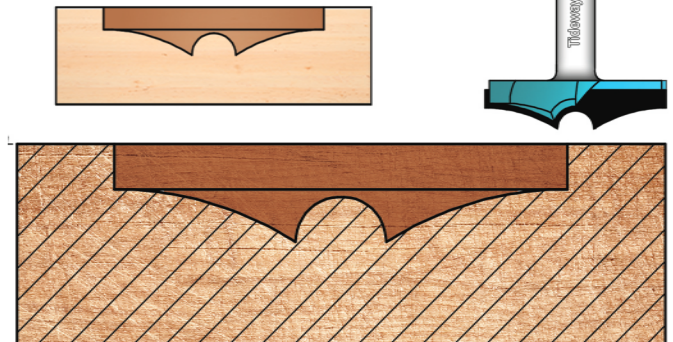
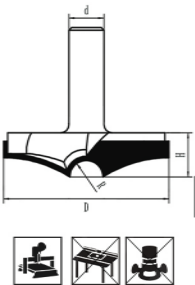

Drawings are 1:1 scale

R	Code No: کد	D عرض (mm)	H کارگیر (mm)	d شفت (mm)	Z دندانه
1	TD-141232	44/5	10/3	12	2

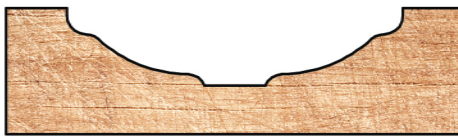
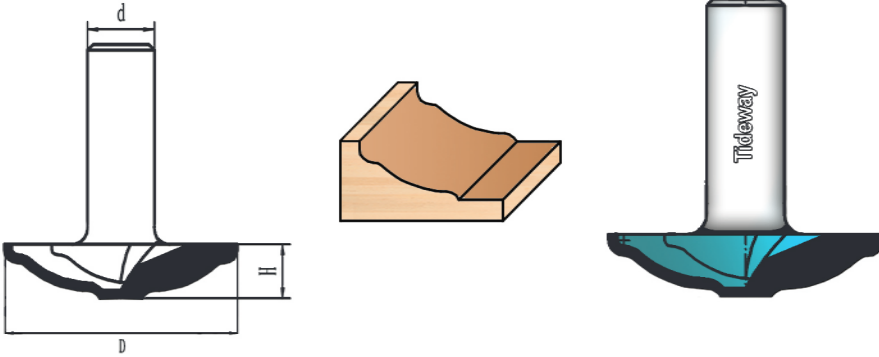

Drawings are 1:1 scale



R	Code No: کد	D عرض (mm)	H کارگیر (mm)	d شفت (mm)	Z دندانه
1	TD-141234	42	9	12	2

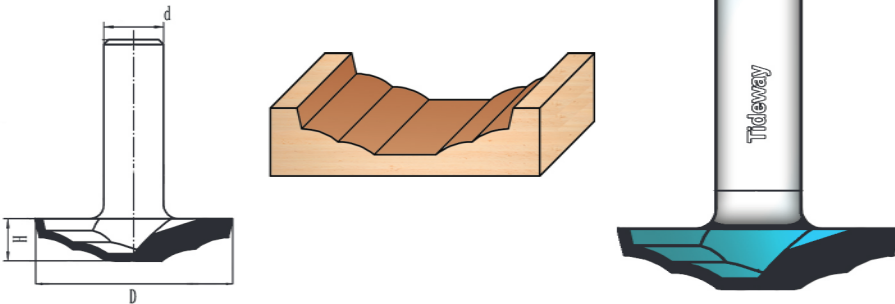

Drawings are 1:1 scale



R	Code No: کد	D عرض (mm)	H کارگیر (mm)	d شفت (mm)	Z دندانه
1	TD-141236	34	12	12	2

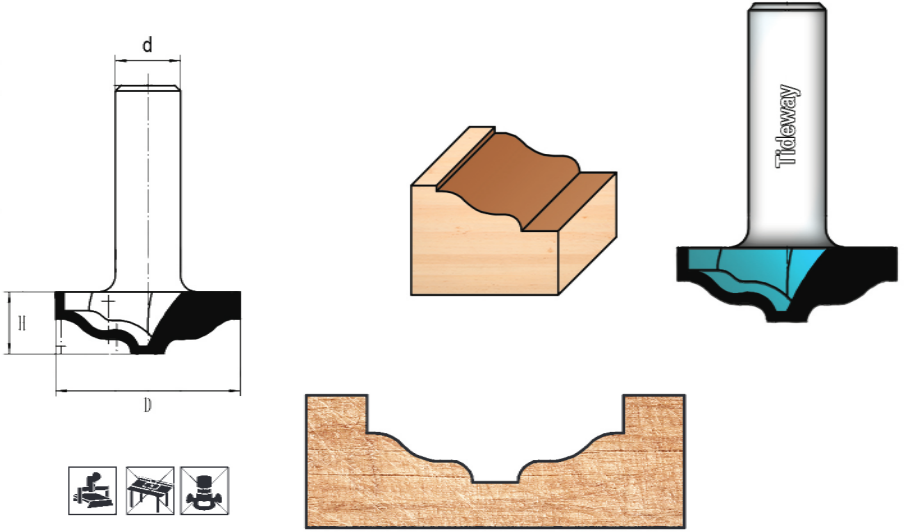

Drawings are 1:1 scale

R	Code No: کد	D عرض (mm)	H کارگیر (mm)	d شفت (mm)	Z دندانه
1	TD-141237	35	8/5	12	2

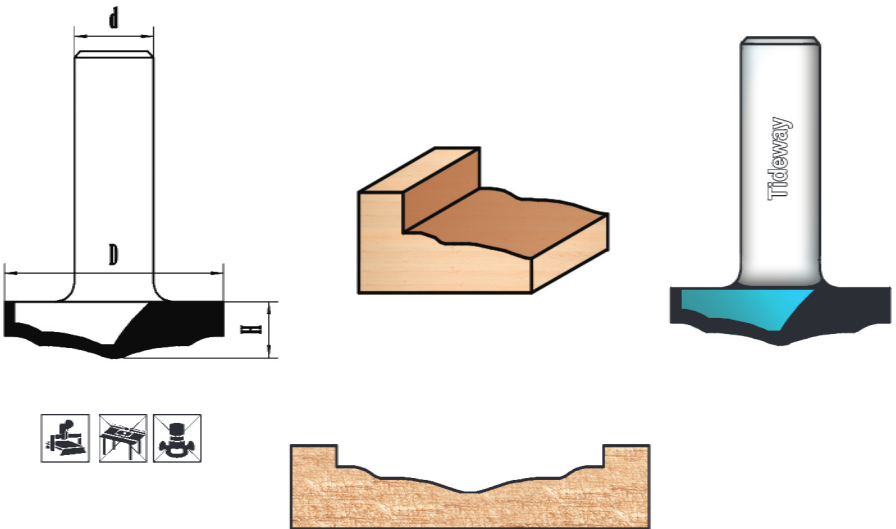

Drawings are 1:1 scale

R	Code No: کد	D عرض (mm)	H کارگیر (mm)	d شفت (mm)	Z دندانه
1	TD-141238	35	8/5	12	2

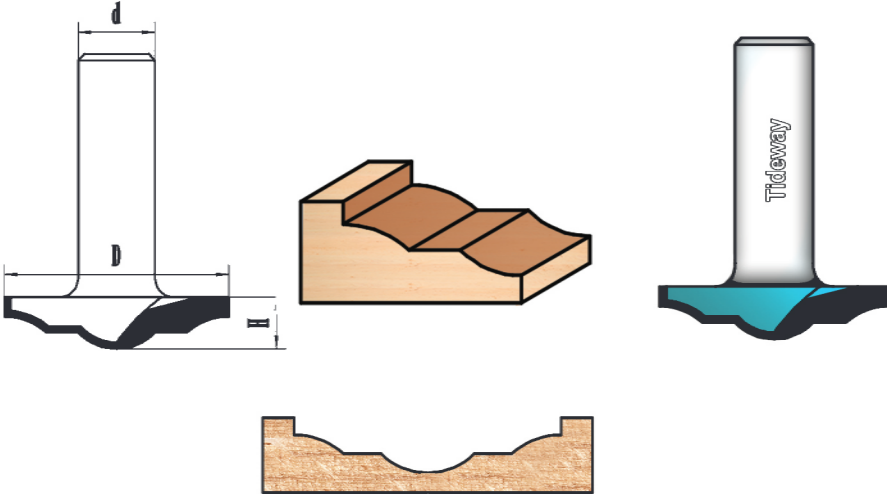

Drawings are 1:1 scale



R	Code No: کد	D عرض (mm)	H کارگیر (mm)	d شفت (mm)	Z دندانه
1	TD-141239	50/8	12	12	2

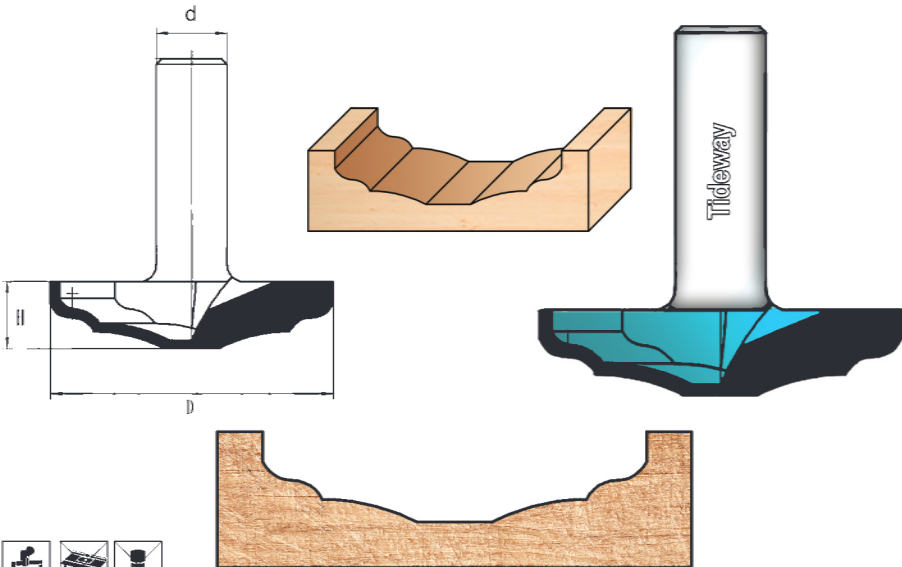

Drawings are 1:1 scale



R	Code No: کد	D عرض (mm)	H کارگیر (mm)	d شفت (mm)	Z دندانه
1	TD-141240	34/9	12	12	2

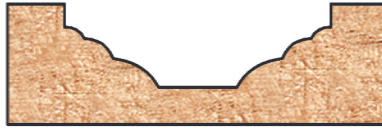
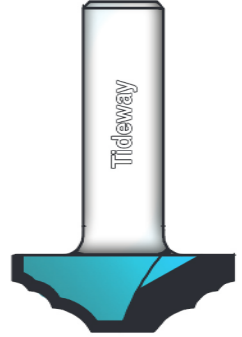
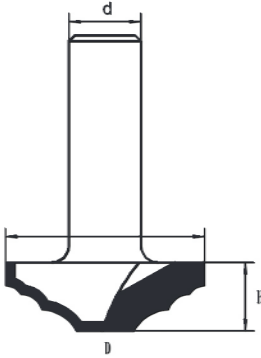

Drawings are 1:1 scale



R	Code No: کد	D عرض (mm)	H کارگیر (mm)	d شفت (mm)	Z دندانه
1	TD-141242	63/5	11	12	2

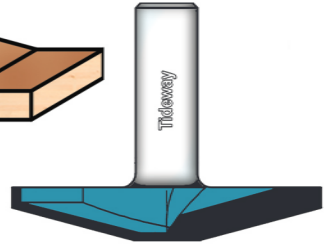
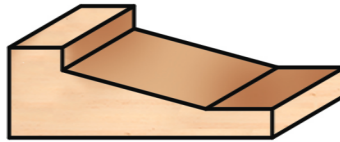
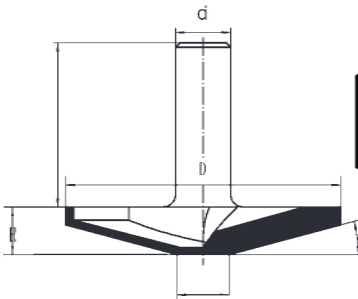

Drawings are 1:1 scale



R	Code No: کد	D عرض (mm)	H کارگیر (mm)	d شفت (mm)	Z دندانه
1	TD-141245	25	5	12	2
2	TD-141243	34	5	12	2
3	TD-141246	50	7	12	2

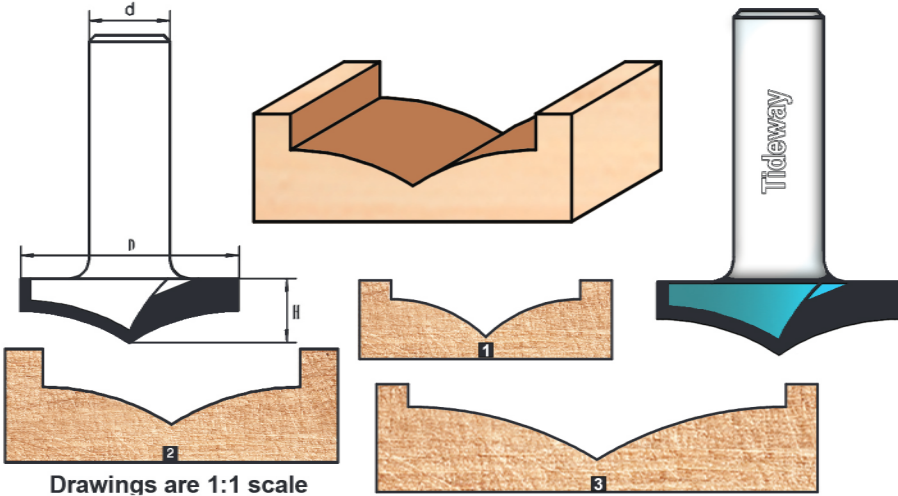

Drawings are 1:1 scale



R	Code No: کد	D عرض (mm)	H کارگیر (mm)	d شفت (mm)	Z دندانه
1	TD-141244	52	13	12	2

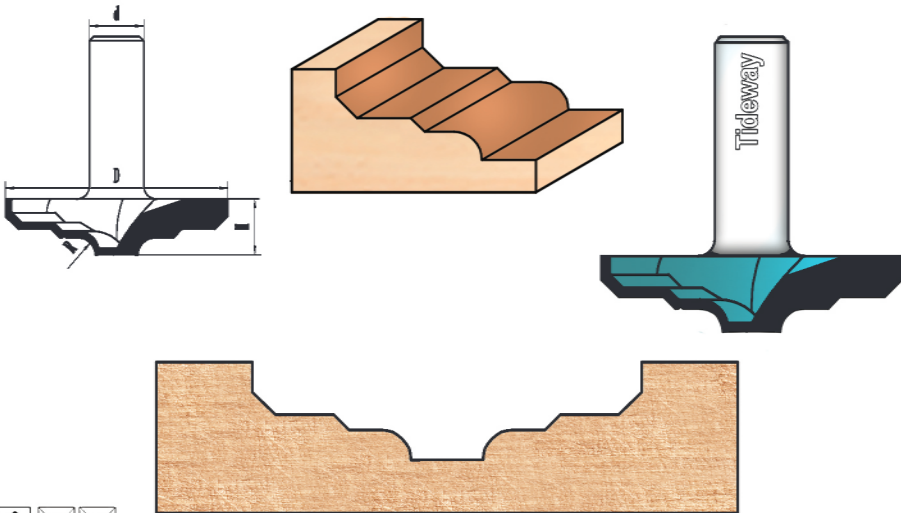

Drawings are 1:1 scale



R	Code No: کد	D عرض (mm)	H کارگیر (mm)	d شفت (mm)	Z دندان
1	TD-501600	8	26	6	2
2	TD-501201	8	26	8	2
3	TD-501202	12/7	38	12	2
4	TD-501203	12/7	50/8	12	2

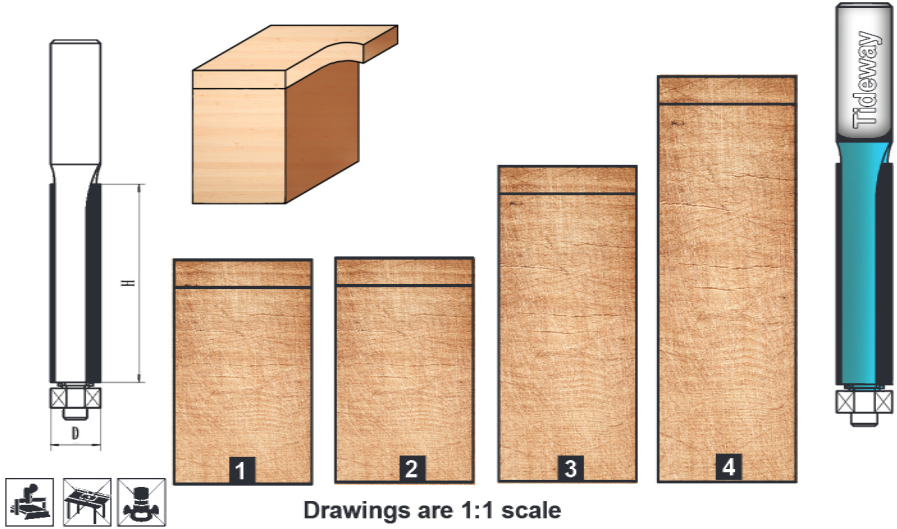

R	Code No: کد	D عرض (mm)	H کارگیر (mm)	d شفت (mm)	Z دندان
1	TD-501806	12/7	26	8	2
2	TD-501807	12/7	38/1	8	2
3	TD-501208	19/05	50	12	2

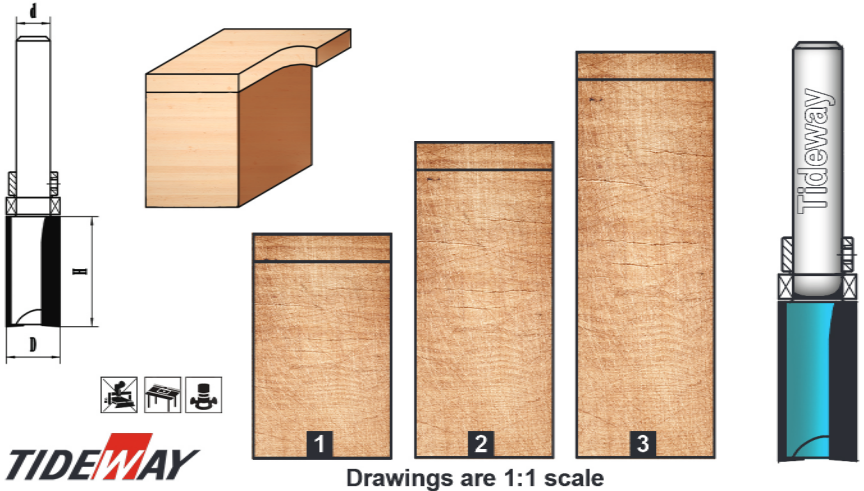

R	Code No: كد	D عرض (mm)	H كارگير (mm)	d شففت (mm)	Z دندانه	a زاويه
1	TD-501620	38	20	6	2	90
2	TD-501221	44/5	22/2	12	2	90
3	TD-501222	57/9	31/75	12	2	90

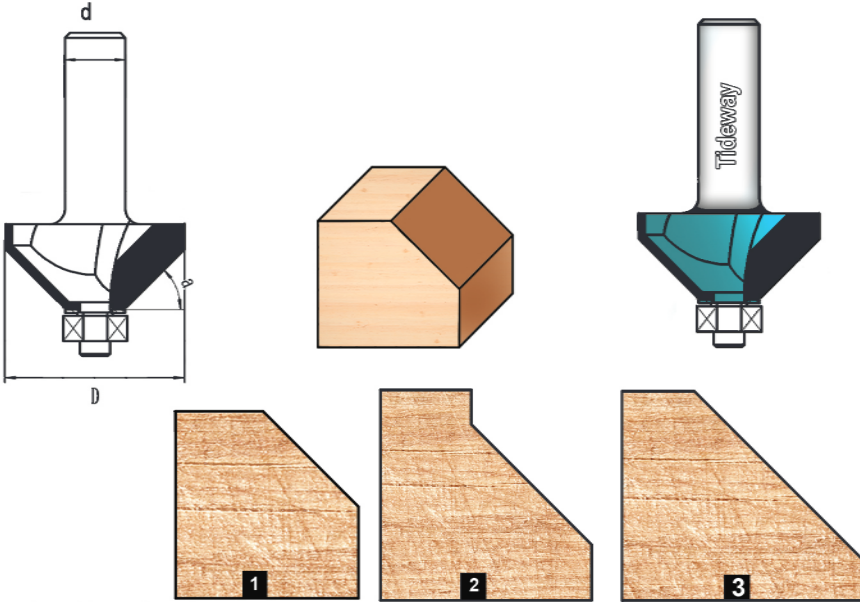

Drawings are 1:1 scale

R	Code No: كد	D عرض (mm)	H كارگير (mm)	d شففت (mm)	Z دندانه
1	TD-501226	47/6	21	12	2

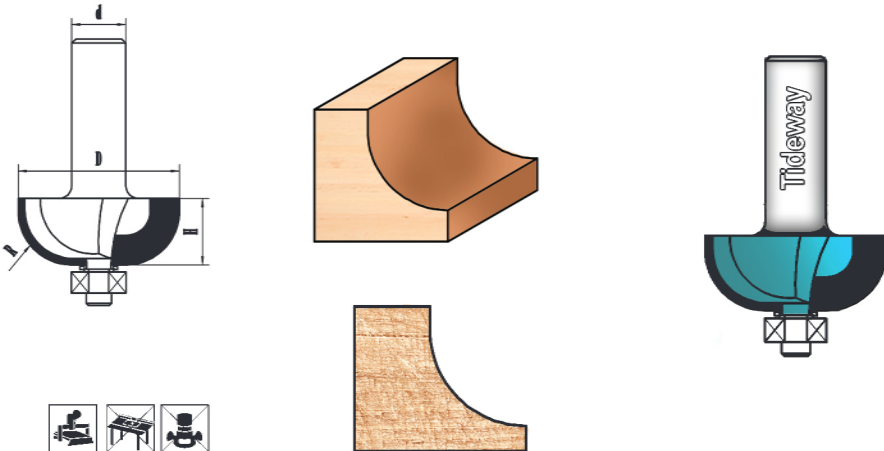

Drawings are 1:1 scale

R	Code No: کد	D عرض (mm)	H کارگیر (mm)	d شفت (mm)	Z دندانه	R شعاع
1	TD-501630	16/7	12/7	6	2	2
2	TD-501832	16/7	12/7	8	2	2
3	TD-501833	20/7	8	8	2	4
4	TD-501834	22/7	9/5	8	2	5
5	TD-501835	28/6	12/7	8	2	8
6	TD-501631	28/6	12/7	6	2	8
7	TD-501236	31/74	16	12	2	9/5
8	TD-501237	36/7	18/5	12	2	12
9	TD-501238	44/7	21/5	12	2	16
10	TD-501239	62/7	32	12	2	25
11	TD-501240	69/86	34/1	12	2	28/58
12	TD-501241	88/9	44	12	2	31/8

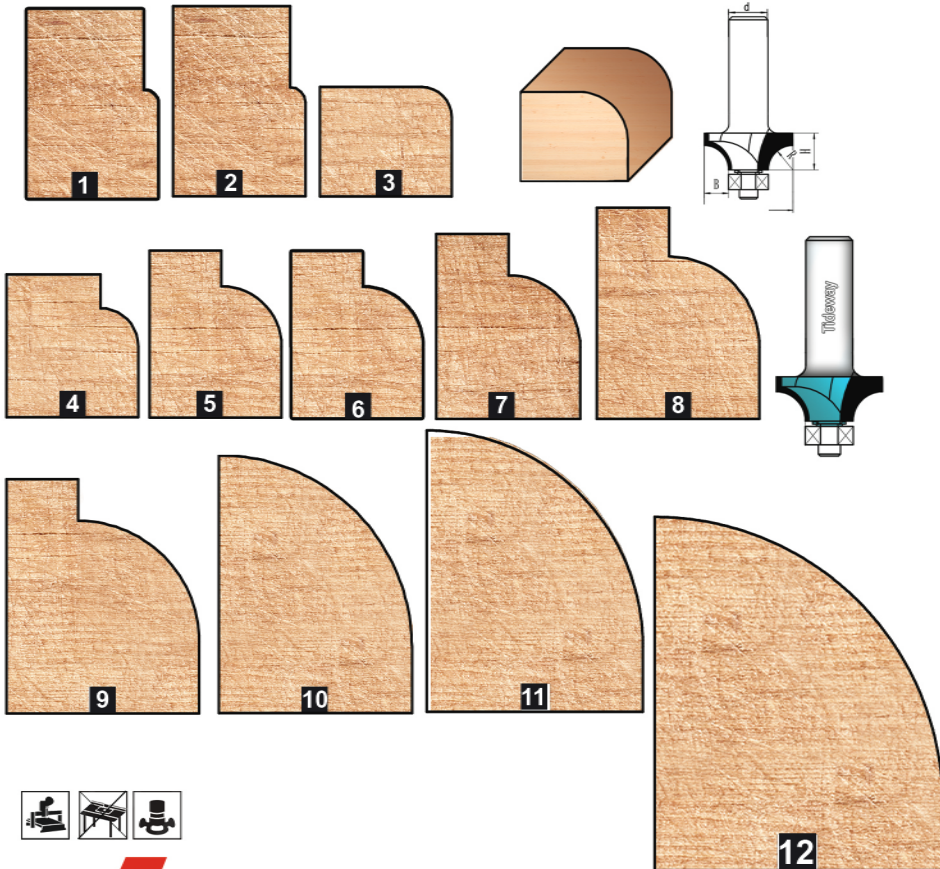

R	Code No: کد	D عرض (mm)	H کارگیر (mm)	d شفت (mm)	Z دندانه
1	TD-501250	38/1	17/5	12	2

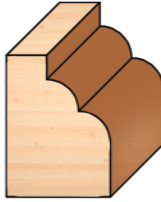
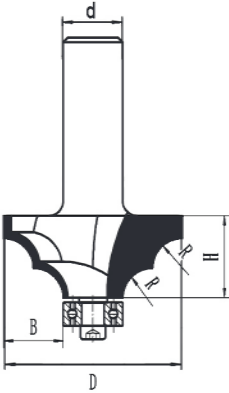

Drawings are 1:1 scale

R	Code No: کد	D عرض (mm)	H کارگیر (mm)	d شفت (mm)	Z دندانه	R شعاع
1	TD-501252	38/1	19/3	12	2	7/14

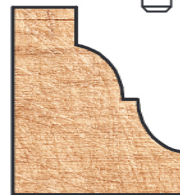
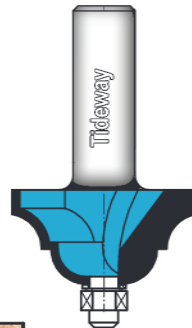
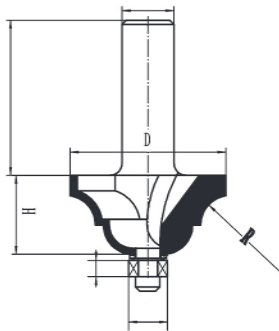

Drawings are 1:1 scale

R	Code No: کد	D عرض (mm)	H کارگیر (mm)	d شفت (mm)	Z دندانه	R شعاع
1	TD-501253	38/1	17	12	2	6/35

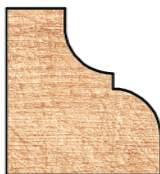
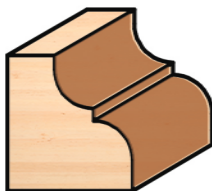
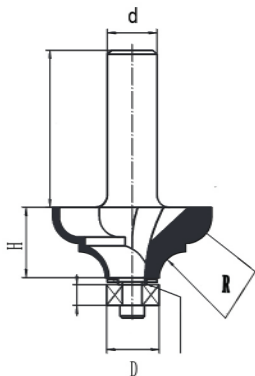

Drawings are 1:1 scale

R	Code No: کد	D عرض (mm)	H کارگیر (mm)	d شفت (mm)	Z دندانه
1	TD-501254	38/1	15/9	12	2

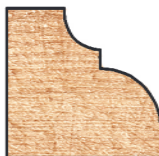
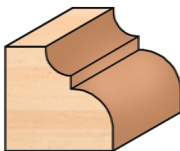
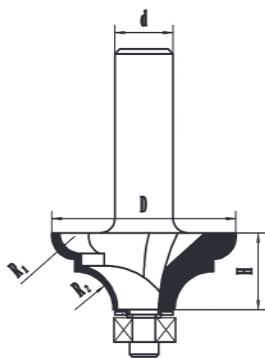

TIDEWAY

Drawings are 1:1 scale

R	Code No: کد	D عرض (mm)	H کارگیر (mm)	d شفت (mm)	Z دندانه
1	TD-501255	57/2	22/2	12	2

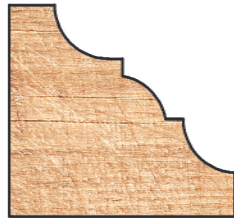
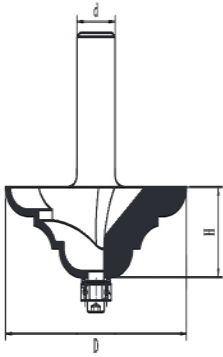

Drawings are 1:1 scale

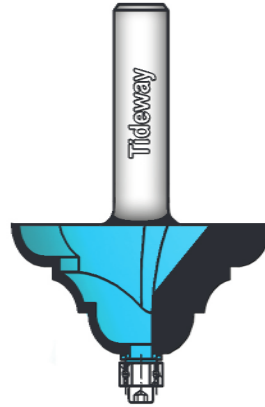
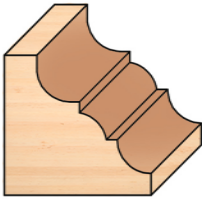

R	Code No: کد	D عرض (mm)	H کارگیر (mm)	d شفت (mm)	Z دندانه
1	TD-501256	41/26	20/2	12	2

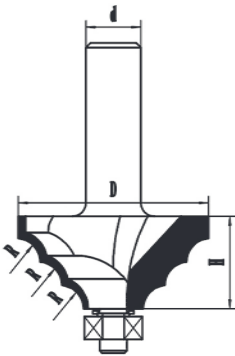

Drawings are 1:1 scale

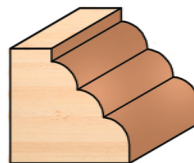

R	Code No: کد	D عرض (mm)	H کارگیر (mm)	d شفت (mm)	Z دندانه	R شعاع
1	TD-501257	32	17	12	2	6/35

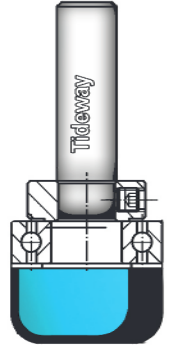
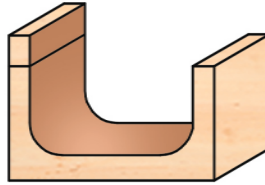
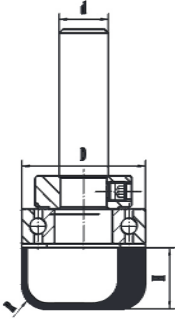

Drawings are 1:1 scale

R	Code No: کد	D عرض (mm)	H کارگیر (mm)	d شفت (mm)	Z دندانه
1	TD-501262	50/8	41/25	12	2

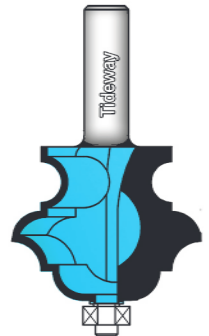
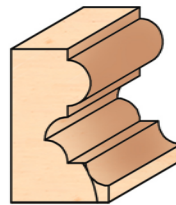
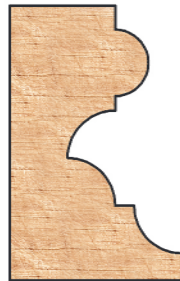
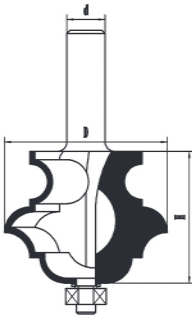

Drawings are 1:1 scale



R	Code No: کد	D عرض (mm)	H کارگیر (mm)	d شفت (mm)	Z دندانه
1	TD-501260	48	40	12	2

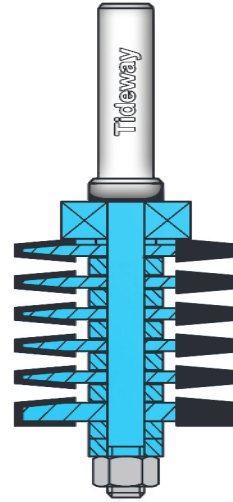
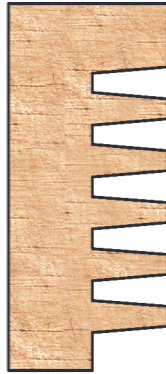
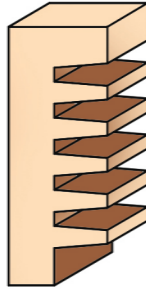
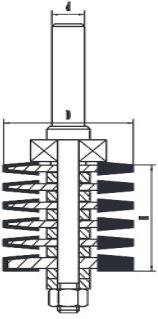

Drawings are 1:1 scale

R	Code No: کد	D عرض (mm)	H کارگیر (mm)	d شفت (mm)	Z دندانه
1	TD-501880	31/75	4	8	2
2	TD-501281	31/8	6/35	8	2

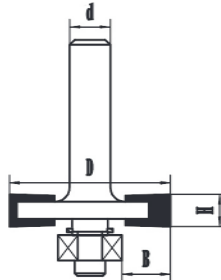
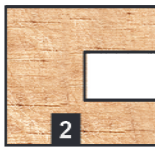
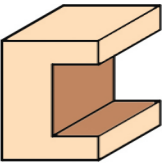

Drawings are 1:1 scale



R	Code No: کد	D عرض (mm)	H کارگیر (mm)	d شفت (mm)	Z دندانه
1	TD-501282	41	19/05	12	2

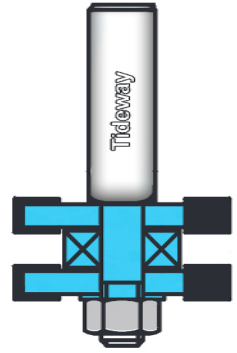
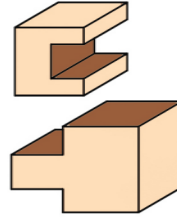
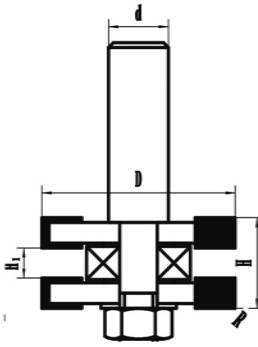

Drawings are 1:1 scale

R	Code No: کد	D عرض (mm)	H کارگیر (mm)	d شفت (mm)	Z دندانه
1	TD-501285	41	35	12	2

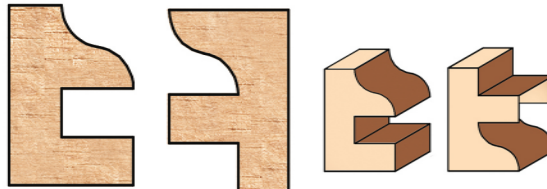
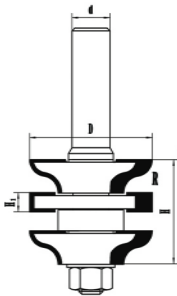

Drawings are 1:1 scale



R	Code No: کد	D عرض (mm)	H کارگیر (mm)	d شفت (mm)	Z دندانه
1	TD-501287	69/8	16/9	12	2

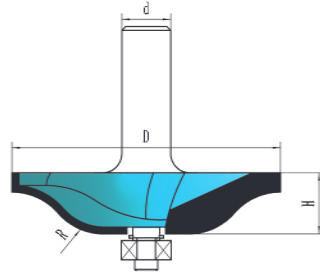
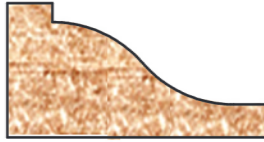
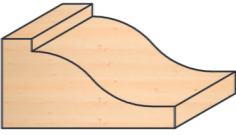

R	Code No: کد	D عرض (mm)	H کارگیر (mm)	d شفت (mm)	Z دندانه	a زاویه
1	TD-501886	34/9	22/2	8	2	9/5

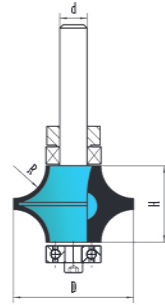
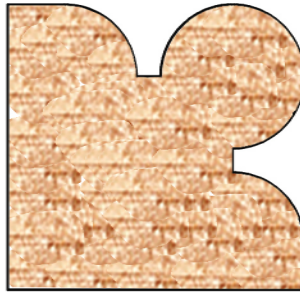
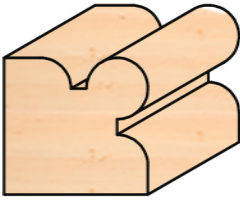

R	Code No: کد	D عرض (mm)	H کارگیر (mm)	L ارتفاع (mm)	d شفت (mm)	Z دندانه
1	Brk-3.163.1	3	16	50	3	1
2	Brk-4.204.1	4	20	50	4	1
3	Brk-5.225.1	5	22	55	5	1
4	Brk-6.226.1	6	22	65	6	1



R	Code No: کد	D عرض (mm)	H کارگیر (mm)	L ارتفاع (mm)	d شفت (mm)	Z دندانه
1	Brk-4.204.2	4	20	50	4	2
2	Brk-5.225.2	5	22	55	5	2
3	Brk-6.226.2	6	22	58	6	2
4	Brk-8.358.2	8	35	82	8	2

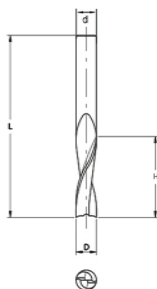

R	Code No: کد	D عرض (mm)	H کارگیر (mm)	L ارتفاع (mm)	d شفت (mm)	Z دندانه
1	Brk-8.328.3	8	32	75	8	3
2	Brk-10.3210.3	10	32	75	10	3
3	Brk-12.5212.3	12	52	110	12	3
4	Brk-16.5216.3	16	52	120	16	3
5	Brk-16.10016.3	16	100	150	16	3

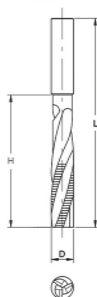

R	Code No: کد	د شفت d	کارگیر H (mm)	ارتفاع L (mm)	R شعاع (mm)	Z	سختی
1	Sp-09368	12	80	130	1/5	2	HSS
2	Sp-09564	12	80	130	1	2	HSS
3	Sp-09714	14	100	150	1/5	2	HSS
4	Brk-3.358.2T	8	35	80	1/5	2	HW
5	Brk-2.358.2T	8	35	80	1	2	HW
6	Brk-3.6012.2T	12	60	120	1/5	2	HW
7	Brk-3.8012.2T	12	80	130	1/5	2	HW

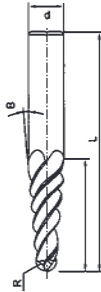

R	مدل	دسته بندی	قطر (mm)	L ارتفاع (mm)
1	ISO30	ER32	50	115

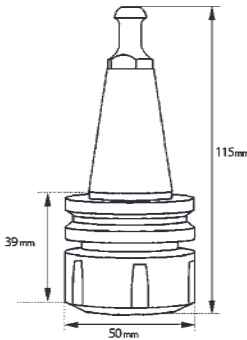

R	دسته بندی	سایز بندی	قطر (mm)	L ارتفاع (mm)
1	ER32	3_2	33	40
2	ER32	4_3	33	40
3	ER32	6_5	33	40
4	ER32	8_7	33	40
5	ER32	10_9	33	40
6	ER32	12_11	33	40
7	ER32	16_15	33	40
8	ER32	20_19	33	40

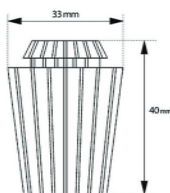

R	دسته بندی	سایز بندی	قطر (mm)	L ارتفاع (mm)
1	ER25	6_5	26	34
2	ER25	8_7	26	34
3	ER25	12_11	26	34

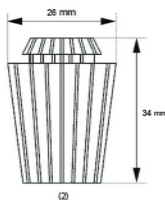

R	دسته بندی	سایز بندی	قطر (mm)	L ارتفاع (mm)
1	ER20	6_5	21	32
2	ER20	8_7	21	32
3	ER20	12_11	21	32

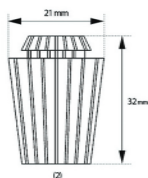

R	Code No: کد	D قطر (mm)	H کارگیر (mm)	d شفت (mm)	Z دندانه
1	2800-321-1	90	12	20	4

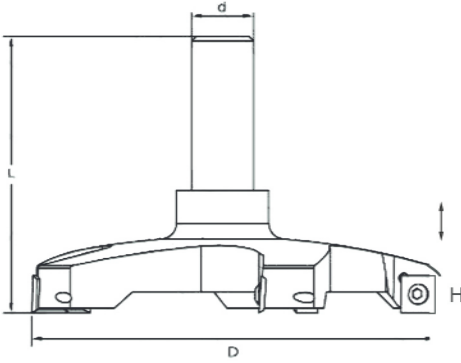

R	Code No: کد	D قطر (mm)	H کارگیر (mm)	d شفت (mm)	Z دندانه
1	2800-325	60	12	20	2

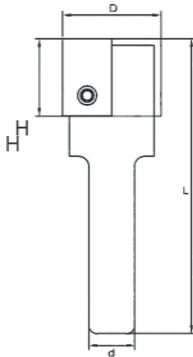

R	Code No: کد	D قطر (mm)	H کارگیر (mm)	d شفت(mm)	Z دندانه	a زاویه
1	2900-100	60	35	20	2	90

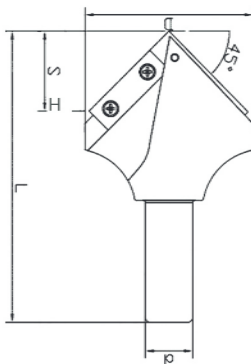

R	Code No: کد	D قطر (mm)	H کارگیر (mm)	d شفت(mm)	Z دندانه
1	0700-020	19	50	12	2

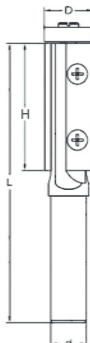

R	Code No: کد	D عرض (mm)	H کارگیر (mm)	d شفت (mm)	Z دندانه
1	0700-035	19	50	20	Z ₂ +1

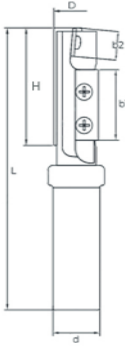

R	Code No: کد	D قطر (mm)	H کارگیر (mm)	d شفت (mm)	Z دندانه
1	1366-9-2	80	80	35	3/3X2
2	1400-4-15	80	125	35	4/5X2

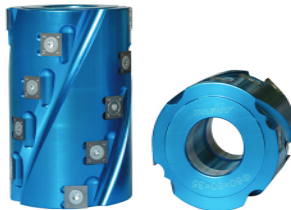

R	Code No: کد	D قطر (mm)	H کارگیر (mm)	d شفت (mm)	Z دندانه
1	SP110-12	85	50	35	4



R	دسته بندی	D قطر (mm)	ارتفاع	قطر داخلی
1	ER32	50	23	38



R	D قطر (mm)	ارتفاع	قطر داخلی
1	8	4	3.5
2	12.7	4.98	4.76



R	SIZE	D عرض (mm)	H کارگیر(mm)	ضخامت
1	30X12X1.5	30	12	1.5
2	40X12X1.5	40	12	1.5
3	50X12X1.5	50	12	1.5
4	14X14X2	14	14	2
5	12X12X1.5	12	12	1.5
6	60X12X1.5	60	12	1.5
7	20X12X1.5	20	12	1.5
8	15X15X2.5 A150	15	15	2.5

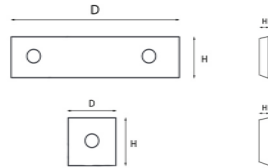

تیغ اره الماسه MDF بر 96

R	Code No: کد	D قطر (mm)	H ضخامت(mm)	d شفت(mm)	Z دندانه	مدل
1	A03040015	350	3/5	30+2	108	V5(TP)
2	A03040002	300	3/2	30+2	96	V5(TP)
3	A030105	300	3/2	30	96	v6(TP)
4	A03040009	250	3/2	30+2	80	V5(TP)

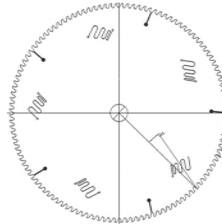
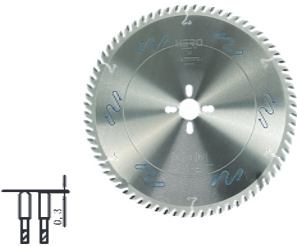

تیغ اره الماسه نئویان بر 97

R	Code No: کد	D قطر (mm)	H ضخامت(mm)	d شفت(mm)	Z دندانه	مدل
1	A03050001	300	3.2	30+2	72	BC
2	A03430003	300	3.2	30+2	96	BC

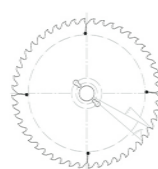
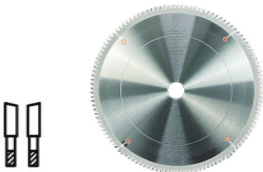

R	Code No: کد	D قطر (mm)	H ضخامت (mm)	d شفت (mm)	Z دندانه	مدل
1	A03050114	250	3.2	30+2	60	BC
2	A03050010	300	3.2	30+2	48	BC
3	A03050115	350	3.5	30+2	72	BC

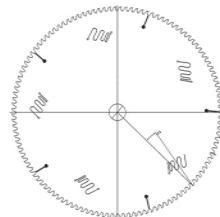

R	Code No: کد	D قطر (mm)	H ضخامت (mm)	d شفت (mm)	Z دندانه	مدل
1	A03020013	120	2.8-3.8/2.2	20	24	BC

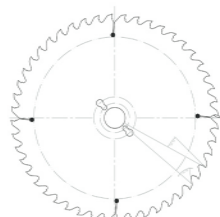

R	Code No: کد	D قطر (mm)	H ضخامت (mm)	d شفت (mm)	Z دندانه	مدل
1	A03040111	180	2.5/1.8	30	54	BC

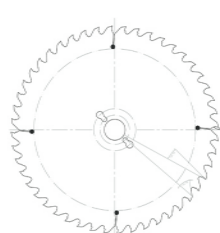

R	CODE.NO	D عرض (mm)	کارگیر(mm)	d شفت	Z دندانه	مدل
1	A03200057	250	3.2/2.2	30	36+2+2T	BCG
2	A03200056	300	3.2/2.2	30	36+2+2T	BCG
3	A03200058	350	3.2/2.2	30	36+2+4T	BCG

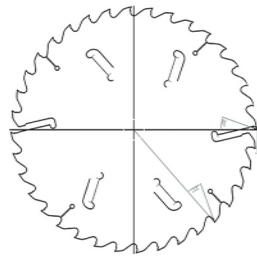

R	CODE.NO	D عرض (mm)	کارگیر(mm)	d شفت	Z دندانه	مدل
1	A03180057	300	3.2/2.2	30	36T	BCGE

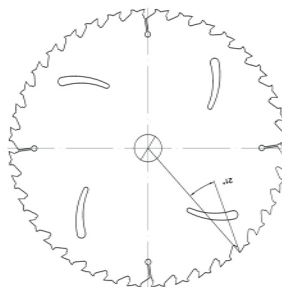

R	CODE.NO	D عرض (mm)	H کارگیر (mm)	d شفت	Z دندانه	مدل
1	A03270212	400	4.0/2.2	32	120	TP
2	A03270213	450	4.0/2/2	32	120	TP

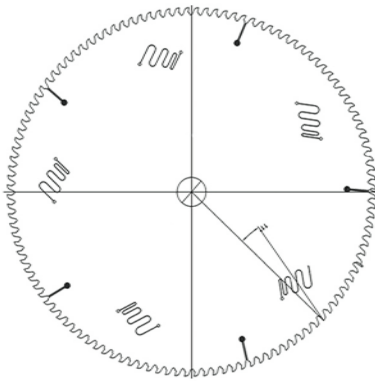

R	CODE.NO	D عرض (mm)	H کارگیر (mm)	d شفت	Z دندانه	مدل
1	A03040148	210	2.8/2.0	30	64	TP
2	A03050186	255	2.8/2.0	30	60	BC

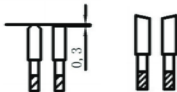
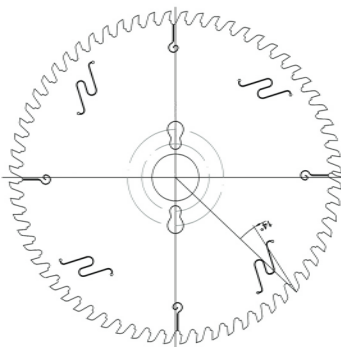



IRANTIGH
شرکت ایران تیغ

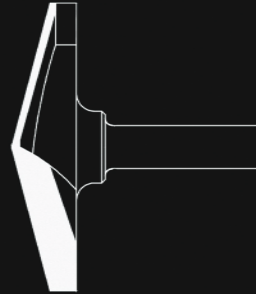
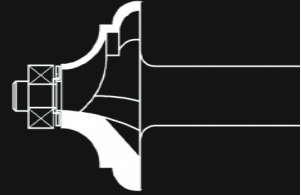

کرج، بلوار یادگار امام، نرسیده به سه راه گوهردشت، نبش بلال ۷، برج نور هشتم، طبقه چهارم، واحد ۷





TIDEWAY

HERO

TOFUZ



 **Irantigh2014**

 **www.irantigh.com**

 **@Irantighwoodtools**

 **Info@irantigh.com**

 **02634238761**

 **02632706835**

 **09196100026**

 **09025941225**

 **09005941225**